

Canon

Exif Print 
PictBridge

Office All-In-One

PIXMA MX300 series

Quick Start Guide



QT51346V01

Getting Help from Canon

Help Us Help You Better

Before you contact Canon, please record the following information.

Serial Number (located on the inside of the product): _____

Model Number (located on the top of the product): _____

Setup CD-ROM number (located on the CD-ROM): _____

Purchase Date: _____

Customer Technical Support Sequence*

1. Internet — www.canontechsupport.com

For quick and comprehensive self-help in an intuitively guided interactive troubleshooting environment, the place to start is our helpful tech support web site. In addition, the latest driver downloads, answers to frequently asked questions, product information, and “where to buy” instructions are found here.

2. Email Tech Support — www.canontechsupport.com

For individual attention to a special issue, try emailing our friendly technical support representatives, specially trained to communicate quick, easy, and logical solutions to your inquiries within 24 hours.

3. Toll-Free Live Tech Support — (1-800-828-4040)

This option provides live telephone technical support, free of service charges, Monday-Saturday (excluding holidays), during your product’s 1 year limited warranty period. Telephone Device for the Deaf (TDD) support is available at (1-866-251-3752).

4. Extended Service and Support — www.canonesp.com

Canon CarePAK Extended Service Plan is a cost-attractive and easy-to-use extended service program that provides up to three full years of service and support coverage at a very attractive price. CarePAK offers toll-free Canon technical support and includes Canon’s superb InstantExchange product replacement program. For further information about extending your Canon service and support, call (1-800-385-2155), or visit our Web site at www.canonesp.com. CarePAK must be purchased during your product’s warranty period.

For more information and updated program specifics, please visit our web site at www.canontechsupport.com.

* Support program specifics are subject to change without notice.

Canon

PIXMA MX300 series

Office All-In-One

Quick Start Guide

Copyright

This manual is copyrighted by Canon U.S.A., Inc. with all rights reserved. Under the copyright laws, this manual may not be reproduced in any form, in whole or in part, without the prior written consent of Canon U.S.A., Inc.

© 2007 Canon U.S.A., Inc.

Disclaimer

Canon U.S.A., Inc. has reviewed this manual thoroughly in order that it will be an easy-to-use guide to your Canon PIXMA MX300 series Office All-In-One. All statements, technical information and recommendations in this manual and in any guides or related documents are believed reliable, but the accuracy and completeness thereof are not guaranteed or warranted, and they are not intended to be, nor should they be understood to be, representation or warranties concerning the products described.

Specifications are subject to change without notice.

As an ENERGY STAR® Partner, Canon Inc. has determined that this product meets the ENERGY STAR® guidelines for energy efficiency.



All information regarding non-Canon products was compiled from publicly available information. No representation is made regarding the accuracy thereof.

About Consumables

Consumables (ink tanks / FINE Cartridges) are available for 5 years after production has stopped.

Trademarks

- "Microsoft" is a registered trademark of Microsoft Corporation.
- "Windows" is a trademark of Microsoft Corporation, registered in the U.S. and other countries.
- "Windows Vista" is a trademark of Microsoft Corporation.
- "Macintosh" and "Mac" are trademarks of Apple Inc., registered in the U.S. and other countries.

Canon U.S.A., Inc.
One Canon Plaza
Lake Success, NY 11042

Table of Contents

- Before Using the Machine2**
 - Operation Panel2
 - Menu Items4
 - Turning the Machine On and Off6
 - Handling the Original Document8
 - Loading Printing Paper9
- Copying17**
 - Making Copies17
 - Changing the Copy Settings17
 - Using Useful Copy Functions19
- Printing from Your Computer20**
 - Printing with Windows20
 - Printing with Macintosh21
- Scanning Images22**
 - Scanning Methods22
- Printing Photographs Directly from a Compliant Device23**
 - Printing Photographs Directly from a Compliant Device23
 - About PictBridge Print Settings25
- Faxing28**
 - Preparing the Machine for Fax28
 - Registering Sender Information32
 - Registering the Destination37
 - Sending Faxes40
 - Using Other Useful Sending Functions44
 - Receiving Faxes45
 - Using Other Useful Receiving Functions51
 - Document Stored in Memory52
 - Summary of Reports and Lists55
- Routine Maintenance57**
 - When Printing Becomes Faint or Colors Are Incorrect57
 - Printing the Nozzle Check Pattern58
 - Examining the Nozzle Check Pattern59
 - Print Head Cleaning60
 - Print Head Deep Cleaning61
 - Aligning the Print Head62
 - Replacing a FINE Cartridge64
 - Keeping the Best Printing Results70
 - Cleaning Your Machine71
- Troubleshooting75**
 - An Error Message Is Displayed on the LCD76
 - LCD Cannot Be Seen At All78
 - An Unintended Language Is Displayed on the LCD79
 - Cannot Install the MP Drivers80
 - Cannot Connect to Computer Properly81
 - Print Results Not Satisfactory82
 - The Print Result Not Satisfactory When Copying86
 - Printing Does Not Start86
 - Paper Does Not Feed Properly87
 - Paper Jams88
 - Error Message Appears on the Computer Screen89
 - Error Message Appears on a PictBridge Compliant Device91
 - Scanning Problems92
 - Problems Receiving Faxes92
 - Problems Sending Faxes94
 - Telephone Problems95
- Appendix 96**
 - How to Use the Documentation Provided96
 - Reading the On-screen Manuals97
 - Specifications98
- Safety Precautions 102**
 - Legal Limitations on Use of Your Product and Use of Images 105
 - Users in the U.S.A.106
 - Users in Canada111
 - Users in New Zealand112
- Index 113**

Before Using the Machine

Operation Panel

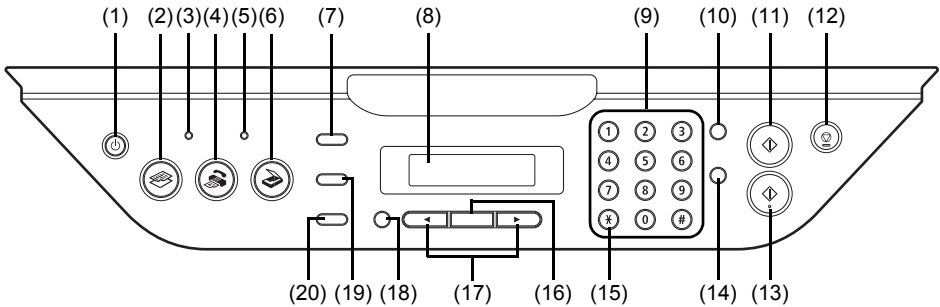

- (1) ON/OFF button / Power lamp**
Turns the machine on and off. Lights or flashes green to indicate the power status. Before turning on the machine, make sure the Document Cover is closed.
- (2) COPY button**
Switches the machine to copy mode.
- (3) In Use/Memory lamp**
Flashes when the telephone line is in use. Lights when there are documents stored in the machine's memory.
- (4) FAX button**
Switches the machine to fax mode.
- (5) Alarm lamp**
Lights or flashes orange when an error, such as paper-out or ink-out, occurs.
- (6) SCAN button**
Switches the machine to scan mode. In scan mode, the machine scans a document to your computer according to the settings selected. To use this button, the machine must be connected to a computer. For details, refer to the *Scanning Guide* on-screen manual.
- (7) Menu button**
Accesses the menus and settings to customize operation of your machine.
- (8) LCD (Liquid Crystal Display)**
Displays messages, menu selections, and the operational status.
- (9) Numeric buttons**
Enter numerical values such as the number of copies, as well as fax/telephone numbers and characters.
- (10) Redial/Pause button**
Redials the last number called using the Numeric buttons. Also enters pauses between or after numbers when dialing or registering numbers.
- (11) Black button**
Starts black & white copying, scanning, or faxing.
- (12) Stop/Reset button**
Cancels operations such as copying, scanning, or faxing, or a print job in progress.
- (13) Color button**
Starts color copying, scanning, or faxing.

(14) Coded Dial button

Press this button and a two-digit code to dial a pre-registered fax/telephone number.

(15) Tone button

Switches temporarily to tone dialing. Also changes the mode when entering characters.

(16) OK button

Finalizes your selection for the menu or setting item.

Dismisses the error message and resumes the machine's normal operation after resolving a printing error or removing jammed paper.

(17) ◀ (-) and ▶ (+) buttons

Scroll through menu selections, and increase or decrease the number of copies.

For the fax settings, ◀ cancels the entered character, and ▶ enters a space between characters.

(18) Back button

Returns the LCD to the previous screen.

(19) Settings button

Configures the page size, media type, and image correction settings.

(20) FAX Quality button

Sets the scan contrast and resolution of the fax you are sending.

Menu Items

Press the **Menu** button to display the menu items.

You can specify the special copy settings, various fax settings, or perform the machine maintenance by using these menu items.

Press the **Settings** button to display the setting items in copy mode or fax mode.

You can specify the various print settings in copy mode, or page size and media type settings in fax mode by using these setting items.

Press the **FAX Quality** button to display the fax quality setting items in fax mode.

You can specify the scan contrast and fax resolution.

For details, refer to the *User's Guide* on-screen manual.

Note

- You can select **DEVICE SETTINGS** and **MAINTENANCE** in any mode.
- Direct Printing mode is displayed only when a PictBridge compliant device is connected to the machine.

● COPY mode

Menu button

SPECIAL COPY*¹

FRAME ERASE
STICKER COPY
BORDERLESS COPY
IMAGE REPEAT
2-ON-1
4-ON-1

FAX SETTINGS

See "FAX SETTINGS" in FAX mode.

DEVICE SETTINGS

MAINTENANCE

Settings button

ENLARGE/REDUCE (page 17)

PAGE SIZE (page 18)

MEDIA TYPE (page 18)

INTENSITY (page 18)

IMAGE QUALITY (page 18)

DEVICE SETTINGS and **MAINTENANCE** under each mode contains the following menu items.

● DEVICE SETTINGS

PRINT SETTINGS*¹

EXTENDED AMOUNT

PICTBRIDGE SET (page 27)

PAGE SIZE
MEDIA TYPE
PRINT QLTY
BORDERLESS PRINT
IMAGE ENHANCEMENT

OTHERS*¹

AUDIBLE TONES
COUNTRY SELECT*²
LANGUAGE SETTING
QUIET MODE

RESTORE DEFAULT*¹

● MAINTENANCE

NOZZLE CHECK (page 58)
CLEANING (page 60)
DEEP CLEANING (page 61)
ALIGN PRINT HEAD (page 62)
HEAD ALIGN PRINT (page 62)
ROLLER CLEANING (page 72)
BOTTOM CLEANING (page 73)

● FAX mode

Menu button

FAX SETTINGS

RECEIVE MODE SET (page 45)

FAX PRIORITY MODE

FAX ONLY MODE

DRPD*³

NETWORK SWITCH*²

TEL PRIORITY MODE

MEMORY REFERENCE (page 52)

PRINT MEMORY LIST

PRINT DOCUMENT

DELETE DOCUMENT

PRNT REPORT/LIST (page 55)

ACTIVITY REPORT

SPEED DIAL LIST

USER'S DATA LIST

MEMORY LIST

CODED DIAL REGIST (page 37)

USER SETTINGS (page 32)

DATE/TIME SETTING

DATE DISPLAY*¹

SUMMER TIME SET*²

UNIT TEL NUMBER

UNIT NAME

TX TERMINAL ID*¹

OFFHOOK ALARM*¹

VOLUME CONTROL*¹

RX RING LEVEL*¹

TEL LINE TYPE (page 30)

ACTIVITY REPORT*¹

TX SETTINGS*¹

ECM TX

PAUSE TIME

AUTO REDIAL

TX START SPEED

TX REPORT

DIAL TONE DETECT

RX SETTINGS*¹

AUTO PRINT RX

ECM RX

FAX PRIORITY MODE

DRPD:FAX RNG PAT*³

RING COUNT

MAN/AUTO SWITCH

REMOTE RX

RX IMG REDUCTION

RX START SPEED

RX REPORT

DEVICE SETTINGS

MAINTENANCE

Settings button

PAGE SIZE (page 50)

MEDIA TYPE (page 50)

FAX Quality button

SCAN CONTRAST (page 41)

FAX RESOLUTION (page 41)

● SCAN mode

Menu button

DEVICE SETTINGS

MAINTENANCE

● Direct Printing mode

Menu button

DEVICE SETTINGS

MAINTENANCE

*¹ For details, refer to the *User's Guide* on-screen manual.

*² This setting may not be available depending on the country or region of purchase.

*³ US and Canada only.

Turning the Machine On and Off

Turn on the machine before printing.

■ Turning on the Machine

Before turning on the machine, confirm the following.

- The FINE Cartridges are installed properly.

If you are using the machine connected to a computer, confirm also the following.

- The machine is connected to your computer (or a compatible device).
- The MP Drivers are installed.

Note

If preparatory operations above are not complete, follow your setup sheet to complete them.

- 1 Press the **ON/OFF** button to turn on the machine.

The **Power** lamp flashes and then remains lit green.

Important

If the **Alarm** lamp lights up or flashes orange and an error message is displayed on the LCD, see “An Error Message Is Displayed on the LCD” on page 76.

- 2 If you are using the machine connected to a computer, turn on your computer.

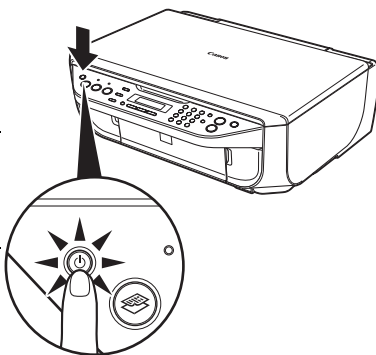

■ Turning off the Machine

- 1 To turn off the machine, press the **ON/OFF** button.

When the **Power** lamp stops flashing, the machine is turned off.

Important

About the Power Plug

When removing the power plug after turning off the machine, be sure to confirm that the **Power** lamp is not lit. If the power plug is removed from the wall outlet with the **Power** lamp still lit or flashing green, the machine may become unable to print.

See “Keeping the Best Printing Results” on page 70.

Note

The power cannot be turned off while the machine is sending or receiving a fax, or when there are unsent faxes stored in the machine's memory.

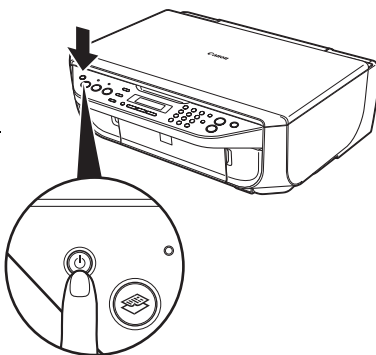

● Screen-saver Mode

The LCD goes out if the machine is not operated for about five minutes*.

Perform a print operation to restore the display.

* You cannot change the wait time before the LCD goes out.

Note

When you want to restore the display, perform any operation such as copying, faxing, or scanning, or press any button except for the **ON/OFF** button. When you press the **ON/OFF** button while the machine is in Screen-saver mode, the machine turns off.

Handling the Original Document

This section describes how to load the original document on the Platen Glass.

■ Original Document Requirements

The original documents you load on the Platen Glass for copying, scanning, or faxing must meet these requirements:

Document type	<ul style="list-style-type: none">● Paper documents● Photographs● Books
Size (W x L)	Max. 8.5 x 11.7 inches / 216 x 297 mm
Thickness	Max. 0.39 inches / 10 mm

■ Loading Original Documents

Load originals to copy, scan, or fax on the Platen Glass.

Note

Make sure any glue, ink, correction fluid, or the like on the original document is completely dry before loading it on the Platen Glass.

1 Load the original document on the Platen Glass.

- (1) Lift the Document Cover.
- (2) Load the original with the side to be copied, scanned, or faxed facing down on the Platen Glass.
Place the original in landscape orientation and align the upper corner of it with the alignment mark as shown in the figure on the right.

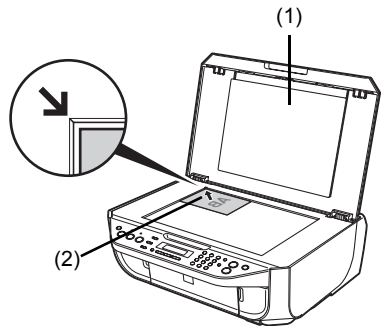

Important

- Do not place any objects weighing more than 4.4 lb / 2.2 kg on the Platen Glass.
- Do not press or put weight on the original with pressure exceeding 4.4 lb / 2.2 kg. Doing so may cause the scanner to malfunction or the Platen Glass to break.

Note

- The machine cannot scan the shaded area in the figure below.

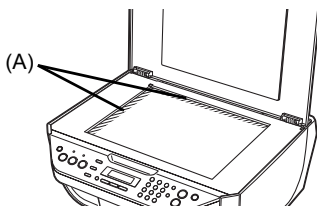

(A) 0.04 inches / 1 mm

- When copying, the area you can scan depends on the printable area of the media. See "Printing Area" in the *User's Guide* on-screen manual.

2 Gently close the Document Cover.

Loading Printing Paper

This section describes how to load printing paper in the Rear Tray.

● Using Specialty Media

Canon recommends that you use Canon genuine media to ensure optimal print quality.

● Photo Quality Media

- Glossy Photo Paper
- Matte Photo Paper
- Photo Paper Plus Double Sided
- Photo Paper Plus Glossy
- Photo Paper Plus Semi-gloss
- Photo Paper Pro
- Photo Stickers



● Media Suited for Business Documents

- High Resolution Paper



■ Paper Handling

● Recommended Paper and Requirements

Media Type	Model ^{*1}	Paper Support Load Limit	Paper Output Tray Load Limit	Paper Thickness Lever ^{*2}	Media Type	
					Machine Setting	Printer Driver Setting
Plain Paper ^{*3}	—	100 sheets	50 sheets	Left	PLAIN PAPER	Plain Paper
Envelopes ^{*4}	—	10 envelopes	1 envelope	Right	—	Envelope
High Resolution Paper ^{*4}	HR-101N	80 sheets	50 sheets	Left	—	High Resolution Paper
Super White Paper	SW-201	80 sheets	50 sheets	Left	PLAIN PAPER	Plain Paper
Glossy Photo Paper ^{*5}	GP-401	A4, Letter, 5" x 7" / 127.0 x 177.8 mm	*6	Left	GLOSSY	Glossy Photo Paper
Glossy Photo Paper "Everyday Use" ^{*5}	GP-501	8" x 10" / 203.2 x 254.0 mm: 10 sheets		Left	GLOSSY	Glossy Photo Paper
Matte Photo Paper	MP-101	4" x 6" / 101.6 x 152.4 mm, Wide, and Credit card: 20 sheets		Left	MATTE PHOTO PAPER	Matte Photo Paper
Photo Paper Glossy	GP-502			Left	GLOSSY	Glossy Photo Paper
Photo Paper Plus Semi-gloss ^{*5}	SG-101, SG-201			Left	PHOTO PAPER PLUS	Photo Paper Plus Glossy
Photo Paper Pro ^{*5}	PR-101			Left	PHOTO PAPER PRO	Photo Paper Pro
Photo Paper Plus Glossy ^{*5}	PP-101			Left	PHOTO PAPER PLUS	Photo Paper Plus Glossy
Photo Paper Plus Double Sided ^{*4*7}	PP-101D	1 sheet		Left	—	Photo Paper Plus Double Sided
Photo Stickers ^{*8}	PS-101	1 sheet		Left	PHOTO PAPER PLUS	Photo Paper Plus Glossy
T-Shirt Transfers ^{*4}	TR-301	1 sheet		Right	—	T-Shirt Transfers

^{*1} Paper with a Model Number is Canon specialty media. Refer to the instruction manual supplied with the paper for detailed information on the printable side and notes on handling paper. For information on the paper sizes available for each Canon genuine paper, visit our website. You may not be able to purchase some Canon genuine papers depending on the country or region of purchase. Paper is not sold in the US by Model Number. Purchase paper by name.

^{*2} If the corners or edges of the paper are smudged, try to print with the Paper Thickness Lever set to the right. It may improve print quality. Reset the Paper Thickness Lever to the left when you finish printing. For details on the Paper Thickness Lever, refer to "Inside" in "Main Components" of the *User's Guide* on-screen manual.

- *3 Proper feeding of paper may not be possible at the maximum capacity depending on the type of paper or environmental conditions (either very high or low temperature and humidity). In such cases, reduce the sheets of paper you load at a time to around half (around 0.2 inches / 5 mm in paper stack height).
- *4 Available only when printing from your computer.
- *5 When loading paper in stacks, the print side may be marked as it is fed in or sheets may be stuck to one another causing them not to be fed properly. In this case, load one sheet at a time.
- *6 We recommend that you remove the previously printed sheet from the Paper Output Tray before continuously printing to avoid blurs and discoloration.
- *7 This paper cannot be used in Macintosh®.
- *8 When copying onto sticker paper, be sure to select **STICKER COPY** in **SPECIAL COPY**. Refer to "Copying on Stickers (STICKER COPY)" in "Using Useful Copy Functions" of the *User's Guide* on-screen manual.
-

Important

- Put unused paper back into the package, and store them avoiding heat, humidity, and direct sunlight.
- Do not touch the printed surface nor stack the printed sheets until the ink is fixed.

Note

For a detailed description of printing media types, refer to "Printing Media" in the *User's Guide* on-screen manual.

● Media Types You Cannot Use

Do not use the following types of paper. Using such paper will not only produce unsatisfactory results, but can also cause the machine to jam or malfunction. Additionally, when printing on A5 or smaller sized paper, do not use paper thinner than a post card, including plain paper or notepad paper cut to a small size.

- Folded, curled, or wrinkled paper
- Damp paper
- Paper that is too thin (weighing less than 17 lb / 64 gsm)
- Paper that is too thick (plain paper, except for Canon genuine paper, weighing more than 28 lb / 105 gsm)
- Picture postcards
- Postcards affixed with photos or stickers
- Any type of paper with holes
- Paper that is not rectangular
- Paper bound with staples or glue
- Paper with adhesives
- Paper decorated with glitter, etc.

■ Loading Paper

● Important

- Load A4, Letter, or Legal-sized plain paper when receiving faxes.
- If you cut plain paper to 4" x 6" / 101.6 x 152.4 mm, 5" x 7" / 127.0 x 177.8 mm, or 2.13" x 3.39" / 54.0 x 86.0 mm (credit card-size) for a trial print, it can cause paper jams.
- You cannot print on postcards affixed with photos or stickers.
- Always load paper in portrait orientation (A). Loading paper in landscape orientation (B) can cause the paper to be jammed.

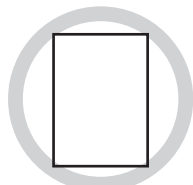

(A)

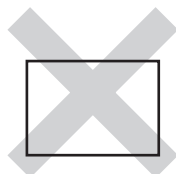

(B)

📖 Note

- We recommend using genuine Canon photo media when printing photographs. For details on the specialty media Canon provides for use with its various printers, see "Using Specialty Media" on page 9.

When Printing on Plain Paper

- You can use general copy paper or Canon's Super White Paper. When printing on both sides, we recommend Canon's Super White Paper Double-Sided.

Paper size:

- Standard sizes: A4, B5, A5, Letter, and Legal
- Non-standard sizes: 2.13 x 3.39 inches to 8.5 x 23 inches / 54.0 x 86.0 mm to 215.9 x 584.2 mm

Paper weight: 17 to 28 lb / 64 to 105 gsm (non-Canon genuine plain paper)

- 1 Flatten the four corners of the paper before loading it.

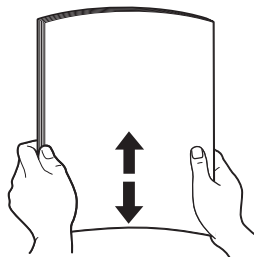

📖 Note

- Align the edges of paper neatly before loading. Loading paper without aligning the edges may cause paper jams.
 - If paper is curled, hold the opposing curled corners and gently bend them in the opposite direction until the paper becomes completely flat. See "Paper is curled." on page 85.
 - To avoid curling, handle paper as follows.
 - Put unused paper back into the package and keep them on a level surface.
 - Take out only the necessary number of sheets from the package, just before printing.
-

2 Prepare to load paper.

- (1) Open the Rear Tray.
- (2) Pull out the Paper Support.
Put your finger in the rounded indent of the Paper Support and pull it out until it stops.
- (3) Open the Paper Output Tray.
Put your finger in the rounded indent beside the Paper Output Tray and open it gently.
- (4) Open the Output Tray Extension.
Open up and set the Output Tray Extension completely by pressing down the hollow on its front side.
- (5) Adjust the position of the Paper Thickness Lever.
Set it to the right when printing on envelopes or T-shirt transfers, and left when printing on any other type of paper. See "Paper Handling" on page 10.

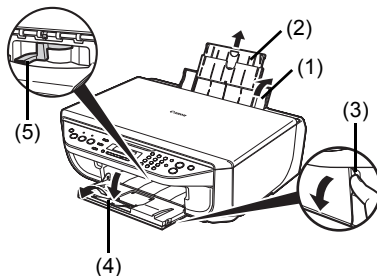

Note

If the corners or edges of the paper are smudged, try to print with the Paper Thickness Lever set to the right. It may improve print quality.
Reset the Paper Thickness Lever to the left when you finish printing.
For details on the Paper Thickness Lever, refer to "Inside" in "Main Components" of the *User's Guide* on-screen manual.

3 Load the paper.

- (1) Load the paper in the Rear Tray with the print side facing UP.
- (2) Align the paper stack against the right side of the Rear Tray.
- (3) Pinch the Paper Guide and slide it against the left side of the paper stack.

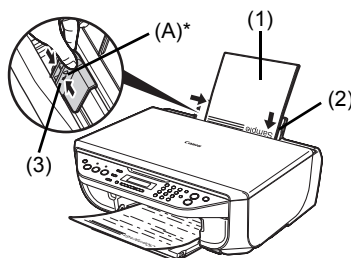

* Do not load higher than the Load Limit Mark (A).

4 Specify the page size and media type settings according to the loaded paper.

Note

- When performing copy direct printing without using a computer, select the size and type of the loaded paper using the Operation Panel.
For details on settings, see "Changing the Copy Settings" on page 17 or "Changing the Print Settings" on page 50.
- When using the machine connected to a computer, select the size and type of the loaded paper in **Page Size** (or **Paper Size**) and **Media Type** in the printer driver.
For details on printer driver settings, see "Printing with Windows" on page 20 or "Printing with Macintosh" on page 21.

■ Loading Envelopes

Use either European DL or US Comm. Env. #10-sized envelope.

Important

- You need to print from the computer to print on envelopes.
 - Do not use the following envelopes:
 - Envelopes with a double flap (or sticker flaps)
 - Envelopes with an embossed or treated surface
 - Envelopes with pressure seals
 - Envelopes whose gummed flaps are already moistened and adhesive
-

1 Prepare the envelopes.

- Press down on all four corners and edges of the envelopes to flatten them.

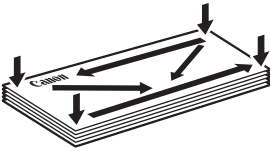

- If the envelopes are curled, hold the opposite corners and gently twist them in the opposite direction.



- If the flap of an envelope is curled, flatten it.
- If the leading edge of an envelope is puffed up or curled, use a pen to press the envelope flat and sharpen the crease.
Press the envelope flat, working from the middle to the edge.

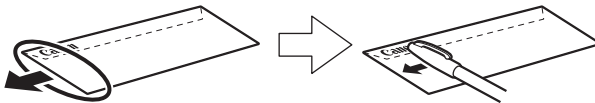

* The above illustrations show a side view of the leading edge of the envelope.

Important

The envelopes may jam in the machine if they are not flat or the edges are not aligned. Make sure that no curl or puff exceeds 0.1 inches / 3 mm.

2 Load the envelopes.

- (1) Load the envelope against the right side of the Rear Tray.
Load with the address side facing UP and the rear flaps DOWN on the left.
Up to 10 envelopes can be loaded at once.
- (2) Pinch the Paper Guide and slide it against the left side of the envelope.

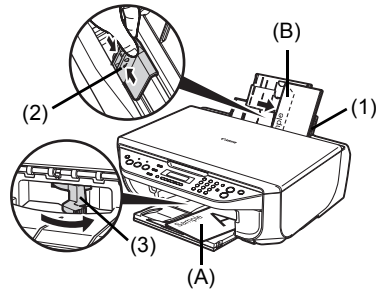

- (A) Printing orientation
(B) Make sure the flaps are folded.

- (3) Set the Paper Thickness Lever to the right.

Note

Reset the Paper Thickness Lever to the left when you finish printing. For details on the Paper Thickness Lever, refer to "Inside" in "Main Components" of the *User's Guide* on-screen manual.

3 Specify the settings in the printer driver.

- (1) Select **Envelope** in **Media Type**.
- (2) Select the size for envelopes.
In Windows®, select **DL Env.** or **Comm. Env. #10** in **Page Size**.
In Macintosh, select **DL Envelope** or **#10 Envelope** in **Paper Size**.
- (3) Select **Landscape** in **Orientation**.

Important

Be sure to set the printer driver setting properly. If you do not, the address will be printed in the wrong direction.

Note

For details on printer driver settings, see "Printing with Windows" on page 20 or "Printing with Macintosh" on page 21.

■ Loading Small-Sized Paper

You can use 4" x 6" / 101.6 x 152.4 mm, 5" x 7" / 127.0 x 177.8 mm, and Credit card-sized papers.

1 Load the paper.

- (1) Load the paper against the right side of the Rear Tray with the print side facing UP.
- (2) Pinch the Paper Guide and slide it against the left side of the paper stack.

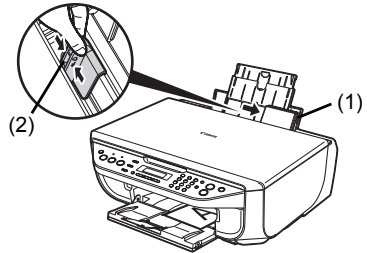

2 Specify the page size and media type settings according to the loaded paper.

Note

- When performing copy direct printing without using a computer, select the size and type of the loaded paper using the Operation Panel.
For details on settings, see "Changing the Copy Settings" on page 17.
 - When using the machine connected to a computer, select the size and type of the loaded paper in **Page Size** (or **Paper Size**) and **Media Type** in the printer driver.
For details on printer driver settings, see "Printing with Windows" on page 20 or "Printing with Macintosh" on page 21.
-

Copying

Making Copies

This section describes the basic procedure to make copies.

- 1 Turn on the machine.
See “Turning the Machine On and Off” on page 6.
- 2 Press the **COPY** button.
- 3 Load paper.
See “Loading Printing Paper” on page 9.
- 4 Load the original on the Platen Glass.
See “Loading Original Documents” on page 8.
- 5 Specify the copy settings.
 - (1) Press the ◀ or ▶ button, or the Numeric buttons to specify the number of copies (max. 99 copies).
 - (2) Press the **Settings** button to adjust the settings as necessary.
For details, see “Changing the Copy Settings” on page 17.
- 6 Press the **Color** button for color copying, or the **Black** button for black & white copying.

Changing the Copy Settings

You can change the copy settings such as the page size, media type, or image quality.

Press the **Settings** button repeatedly to switch the item to set.

Note

- The * (asterisk) on the LCD indicates the current setting.
 - The settings of the page size, media type, and image quality are retained even if the machine is turned off.
-

■ ENLARGE/REDUCE

Select the reduction/enlargement method.

For details, refer to “Reducing or Enlarging a Copy” in “Making Copies” of the *User's Guide* on-screen manual.

Ex: 

PRESET RATIO / ZOOM / FIT-TO-PAGE

■ PAGE SIZE

Select the page size of the loaded paper.

Ex: 

8.5"x11" / A4 / B5 / A5 / 4"x6" / 5"x7" / CREDIT CARD SIZE

Note

Some of these are not available depending on the country or region of purchase.

■ MEDIA TYPE

Select the media type of the loaded paper.

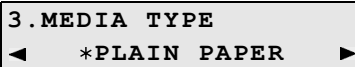
Ex: 

PLAIN PAPER / PHOTO PAPER PRO / PHOTO PAPER PLUS / MATTE PHOTO PAPER / GLOSSY

■ INTENSITY

Change the intensity.

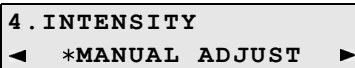
Ex: 

MANUAL ADJUST / AUTO ADJUST (A)

Note

If you select **MANUAL ADJUST**, use the ◀ button to decrease the intensity or the ▶ button to increase it.

If you select **AUTO ADJUST (A)**, **A** appears on the LCD.

■ IMAGE QUALITY

Adjust print quality according to the original.

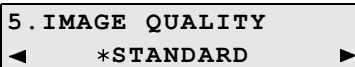
Ex: 

STANDARD / HIGH / FAST

Note

- **FAST** can be selected only when this setting is set to **PLAIN PAPER**.
 - When using **FAST**, if the quality is not as good as expected, select **STANDARD** or **HIGH** and try copying again.
 - Select **HIGH** to copy in grayscale. Grayscale renders tones in a range of grays instead of black or white.
-

Using Useful Copy Functions

For details, refer to "Using Useful Copy Functions" in the *User's Guide* on-screen manual.

Reducing or Enlarging a Copy (ENLARGE/REDUCE)

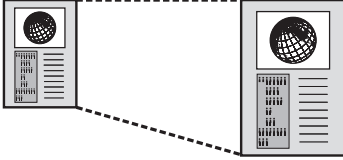

Copying Thick Originals Such as Books (FRAME ERASE)



Copying on Stickers (STICKER COPY)

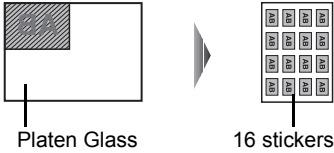

Copying without Borders (BORDERLESS COPY)

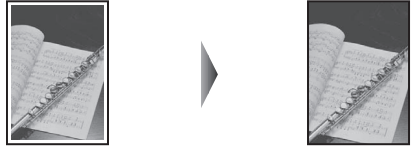

Repeating an Image on a Page (IMAGE REPEAT)

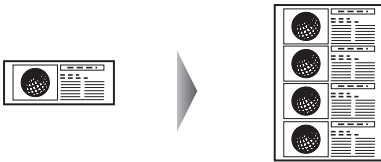

Copying Two Pages to Fit onto a Single Page (2-ON-1)



Copying Four Pages to Fit onto a Single Page (4-ON-1)

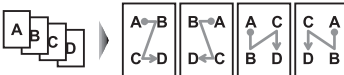

Printing from Your Computer

This section describes procedure for basic printing.

Printing with Windows

Note

Depending on your application program, operations may differ. For details, refer to the instruction manual of your application.

The steps described in this section are for printing in Windows Vista™ operating system (hereafter referred to as “Windows Vista”).

- 1 Turn on the machine and load the paper in the machine.
See “Turning the Machine On and Off” on page 6 and “Loading Printing Paper” on page 9.
- 2 Create a document or open a file to print using an appropriate application software.
- 3 Select **Print** on the application software’s **File** menu.
- 4 Make sure that **Canon XXX Printer** (where “XXX” is your machine’s name) is selected in **Select Printer**, and click **Preferences** (or **Properties**).

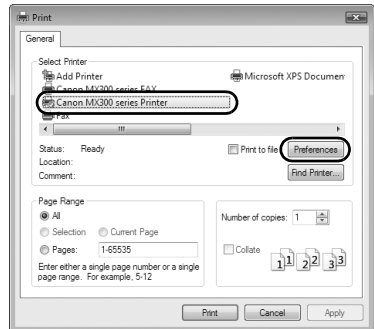

- 5 Specify the required settings and click **OK**.

Note

For details on the printer driver functions, click **Help** or **Instructions** to view the online help or the *PC Printing Guide* on-screen manual. **Instructions** is only displayed when the on-screen manuals are installed.

- 6 Click **Print** (or **OK**).

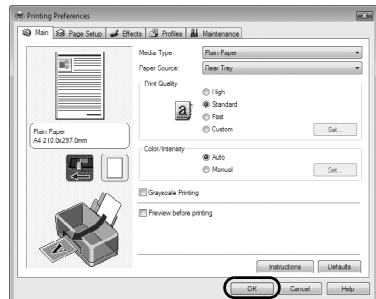

Printing with Macintosh



Note

Depending on your application program, operations may differ. For details, refer to the instruction manual of your application.

The steps described in this section are for printing in Mac[®] OS X v.10.4.x.

- 1 Turn on the machine and load the paper in the machine.
See “Turning the Machine On and Off” on page 6 and “Loading Printing Paper” on page 9.
- 2 Create a document or open a file to print using an appropriate application software.
- 3 Select **Page Setup** on the application software’s **File** menu.
- 4 Make sure that your machine’s name is selected in **Format for**.
- 5 Select the page size of the loaded paper in **Paper Size**.
- 6 Click **OK**.
- 7 Select **Print** on the application software’s **File** menu.
- 8 Select **Quality & Media** in the pop-up menu.
- 9 Specify the required settings.

Note

For details on the printer driver functions, click  to view the *PC Printing Guide* on-screen manual. If the on-screen manuals are not installed, the *PC Printing Guide* on-screen manual is not displayed even if  is clicked.

- 10 Click **Print**.

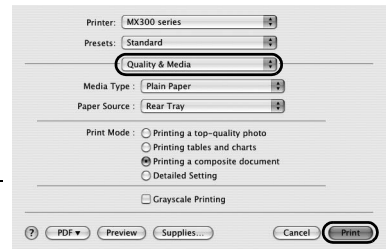
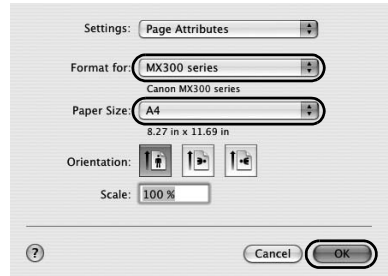

Scanning Images

You can scan images from the machine to a computer without printing them and save them in popular image types such as JPEG, TIFF, bitmaps, or PDF. If you are scanning printed text, you can use the OCR (Optical Character Recognition) software to convert it to text data.

Scanning Methods

You can select from the various scanning methods.

● If You Want to Edit or Print the Scanned Images

MP Navigator EX enables you to edit the scanned images, such as optimizing or trimming.

You can also start application software from MP Navigator EX to edit or print the scanned images.

For detailed operations of MP Navigator EX, refer to the *Scanning Guide* on-screen manual.

You can also use the Operation Panel to open MP Navigator EX as well as open it using the computer.

See “Opening MP Navigator EX using the Operation Panel” on page 22.

● If You Want to Scan Originals with Advanced Settings

ScanGear enables you to scan originals with advanced settings such as the resolution.

For detailed operations of ScanGear, refer to the *Scanning Guide* on-screen manual.

Besides the above-mentioned methods, you can use a TWAIN- or WIA- (Windows Vista and Windows XP only) compliant application software and the Control Panel (Windows Vista and Windows XP only) to scan originals with this machine. For detailed operations, refer to the *Scanning Guide* on-screen manual.

■ Opening MP Navigator EX using the Operation Panel

- 1** (Macintosh only) Prepare your computer before scanning.
This operation is not necessary for Mac OS X v.10.4.x.
For details, refer to “Scanning Methods” in the *User’s Guide* on-screen manual.
- 2** Turn on the machine.
See “Turning the Machine On and Off” on page 6.
- 3** Load the original document on the Platen Glass.
See “Handling the Original Document” on page 8.
- 4** Press the **SCAN** button, then press the **Color** or **Black** button.

Printing Photographs Directly from a Compliant Device

You can connect a PictBridge compliant device such as a digital camera, camcorder, or mobile phone using a USB cable recommended by the device's manufacturer, and print recorded images directly without using a computer.

● Connectable Devices

PictBridge is an industry standard enabling a range of digital photo solutions, including the direct printing of photos from a digital still camera, camcorder or mobile phone* without the need to use a computer. A device can be connected to this machine for direct printing regardless of the manufacturer or the model as long as it complies with the PictBridge standard.

* PictBridge compliant digital still cameras, digital camcorders, and camera-equipped mobile phones are hereafter collectively referred to as "PictBridge compliant device".

 A device with this mark is PictBridge compliant.

● Printable Image Data Format

This machine prints images taken with a DCF (Design rule for Camera File system) ver. 1.0/2.0-compatible digital camera (Exif ver. 2.2/2.21 compliant), as well as PNG files.

Printing Photographs Directly from a Compliant Device

To connect a PictBridge compliant device to this machine, use a USB cable recommended by the device's manufacturer.

Caution

Do not connect any equipment other than PictBridge compliant devices to the Direct Print Port of the machine. If you do so, electric shock, fire, or damage to the machine could result.

Important

Never disconnect the USB cable during printing unless when explicitly allowed to by the PictBridge compliant device. When disconnecting the USB cable between the PictBridge compliant device and machine, follow the instructions given in the device's instruction manual.

Note

When printing photos with the PictBridge compliant device connected to the machine, we recommend the use of the AC adapter supplied with the device. If you are using the device battery, be sure to charge it fully.

1 Prepare for printing.

- (1) Turn on the machine.
See "Turning the Machine On and Off" on page 6.
- (2) Load paper.
See "Loading Printing Paper" on page 9.

2 Connect the PictBridge compliant device to the machine.

Note

Depending on the model or brand of your device, you may have to select a print mode compliant with PictBridge before connecting the device. You may also have to turn on the device or select Play mode manually after connecting the device to the machine.

Perform necessary operations on the PictBridge compliant device before connecting it to this machine according to instructions given in the device's instruction manual.

(1) Make sure that the PictBridge compliant device is turned off.

(2) Connect the PictBridge compliant device to the machine using a USB cable recommended by the manufacturer of the device.

The device turns on automatically.

If your device does not turn on automatically, turn it on manually.

(3) Set up the PictBridge compliant device for direct printing.

 will appear on the LCD of the device when the machine is correctly connected.

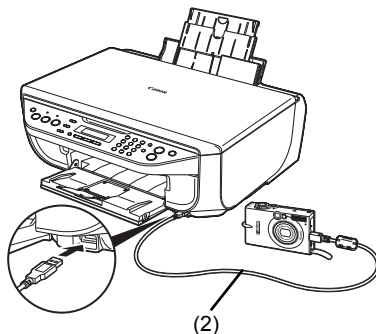

3 Specify the print settings such as paper type and layout.

See “About PictBridge Print Settings” on page 25.

You can make settings using the menu on the LCD of your PictBridge compliant device.

Select the size and type of paper that you loaded in the machine.

If your PictBridge compliant device does not have setting menu, change the setting from the machine. For details, see “Setting on the Machine” on page 27.

4 Start printing from your PictBridge compliant device.

About PictBridge Print Settings

■ Settings on a PictBridge Compliant Device

This section describes the print settings on a PictBridge compliant device. When operating the device, be sure to follow the instructions given in the instruction manual of your PictBridge compliant device.

Note

- In the following description, names of setting items are given according to those used in Canon-brand PictBridge compliant devices. Setting item names may be different depending on the brand or model of your device.
- Some setting items explained below may not be available on some devices. In this case, the settings made on the machine are applied. Also, when some items are set to **Default** on a PictBridge compliant device, the machine settings for these items are applied. For details, see "Setting on the Machine" on page 27.

● Paper Size and Paper Type Settings

The following sizes and types of printing paper can be used when printing from a PictBridge compliant device.

- Paper size
4" x 6" / 101.6 x 152.4 mm, 5" x 7" / 127.0 x 177.8 mm^{*1}, Credit card, 8" x 10" / 203.2 x 254.0 mm, A4, Letter, Wide^{*1}
- Paper type

Paper Type Setting	Loadable Paper ^{*3}
Plain Paper ^{*2}	Super White Paper or other plain paper
Photo	Photo Paper Plus Glossy
	Glossy Photo Paper
	Glossy Photo Paper "Everyday Use"
	Photo Paper Glossy
	Photo Paper Plus Semi-gloss ^{*4}
	Photo Stickers ^{*5}
Fast Photo	Photo Paper Pro

The available page sizes vary depending on the media type. For details, visit our website.

^{*1} Can be selected only on certain Canon-brand PictBridge compliant devices.

^{*2} **Plain Paper** can be selected for **Paper type** only when **Paper size** is set to **A4** or **8.5" x 11" (Letter)**. When **Paper type** is set to **Plain Paper**, borderless printing will be disabled even when **Layout** is set to **Borderless**.

^{*3} You may not be able to purchase some Canon genuine papers depending on the country or region of purchase.

^{*4} When printing on Photo Paper Plus Semi-gloss 8" x 10" / 203.2 x 254.0 mm (SG-201), select **20 x 25 cm/8" x 10"** for **Paper size** and **Default** for **Paper type**.

* Select **PHOTO PAPER PLUS** for **MEDIA TYPE** in the **PICTBRIDGE SET** setting on the machine.

See "Setting on the Machine" on page 27.

^{*5} Exclusively used to print photo stickers. When printing on sticker paper, select **10 x 15 cm/4" x 6"** in **Paper size** and **Photo** for **Paper type**. Do not set **Layout** to **Borderless**.

● Layout Setting

Various layout options are available.

- Bordered/Borderless: You can select whether or not to print an image with a border.
- N-up: You can use this option when printing on sticker paper, or A4- or Letter-sized paper.
Sticker paper: When you select **10 x 15 cm/4" x 6"** for **Paper size**, you can print 16 images on a single sheet of paper.
A4- or Letter-sized paper: When you select **A4 or 8.5" x 11" (Letter)** for **Paper size**, you can print 4 images on a single sheet of paper.
- Shooting Info (Exif Data): You can print shooting info (Exif Data) along with the image. The following two options are available.
1-up^{*1}: Prints the shooting info (Exif Data) in the margin of selected individual images.
20-up^{*2}: Prints 20 images specified with DPOF^{*3} and their shooting info (Exif Data) in list format on a single sheet of paper.
- 35 mm Film Style Layout (Contact Printing Layout)^{*2}: You can print the multiple images specified with DPOF^{*3} in a list format that looks like a negative film.

Besides the above options, you can also specify to print an index of images in the DPOF^{*3} print settings menu.

^{*1} You can use this option only when **10 x 15 cm/4" x 6"**, **13 x 18 cm/5" x 7"**, **20 x 25 cm/8" x 10"**, **A4 or 8.5" x 11" (Letter)** is selected for **Paper size**.

^{*2} You can use this option only when **A4 or 8.5" x 11" (Letter)** is selected for **Paper size**.

^{*3} DPOF (Digital Print Order Format) is a standard format to record the specified information regarding images, such as which image or number of copies to print.

● Date/File No. Print Setting

You can specify whether the date and/or file number will be printed.

Note

- If the images already have dates superimposed when shot, set this PictBridge setting item to **Off**. If you select **Date**, **File No.**, or **Both**, the date and/or file number will be printed over the date printed by the device's function.
 - Depending on the paper size and layout, the date will only be printed even when **Both** is selected.
-

● Image Optimize Setting

You can select the optimization method to obtain high print quality. When you select **On**, the shooting information is used to print the optimized image.

If you are using a Canon-brand PictBridge compliant device, the following additional options may be available, depending on the model.

- **VIVID** makes green and blue more lively.
- **NR** (Noise Reduction) reduces the noise on blue areas like the sky as well as on black areas.
- **Face** brightens a darkened face on the photo taken against the light.
- **Red-Eye** corrects red eyes in portraits caused by flash photography.

● Trimming Setting

You can select an area to print.

■ Setting on the Machine

This section describes the PictBridge print settings on the machine.

Set the print settings to **Default** on the PictBridge compliant device when you want to print according to the settings on the machine.

● Displaying the PictBridge Settings Screen and Specifying the Settings

- 1 Turn on the machine.
- 2 Press the **Menu** button repeatedly until **DEVICE SETTINGS** appears.
- 3 Press the ◀ or ▶ button to select **PICTBRIDGE SET**, then press the **OK** button.
- 4 Press the ◀ or ▶ button to specify the setting item, then press the **OK** button.
- 5 Repeat step 4 to specify each setting item as necessary.

● Setting Items

Setting Item	Description	Corresponding Setting of PictBridge Compliant Devices*
PAGE SIZE	Select the page size, when printing directly from a PictBridge compliant device.	Paper size
MEDIA TYPE	Select the media type, when printing directly from a PictBridge compliant device.	Paper type
PRINT QLTY	Select the print quality, when printing directly from a PictBridge compliant device.	—
BORDERLESS PRINT	Select bordered or borderless print.	Layout
IMAGE ENHANCEMENT	Selects whether to optimize photos with the functions below or not. When SET is selected, you can configure the following.	Image optimize
VIVID	Makes green and blue more lively.	
POP	Automatically optimizes brightness and tone of a photo.	
REMOVE NOISE	Reduces the noise on blue areas like the sky as well as on black areas.	
FACE BRIGHT	Brightens a darkened face on the photo taken against the light.	
RED EYE CORR	Corrects red eyes in portraits caused by flash photography.	

* Set the items in this column to **Default** on the PictBridge compliant device when you want to make settings on the machine.

Faxing

Preparing the Machine for Fax

Typical examples of connecting the machine are described below. The machine cannot send/receive faxes if the connection is incorrect. Connect the machine correctly.

Important

If the Power Disconnects Unexpectedly

If there is a power failure or if you accidentally disconnect the power cord, the date/time settings as well as all documents stored in memory will be lost. User data and speed dialing settings are retained. If the power disconnects, the following will apply:

- You will not be able to send or receive faxes or make copies.
 - If a telephone is connected to the machine, you can receive voice calls.
 - Whether you are able to make voice calls depends on the type of your telephone.
-

■ Methods of Connecting External Devices

● Connecting to an Analog Line

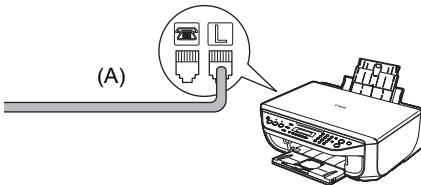

(A) Telephone line (analog)

● Connecting a Telephone or Answering Machine Directly

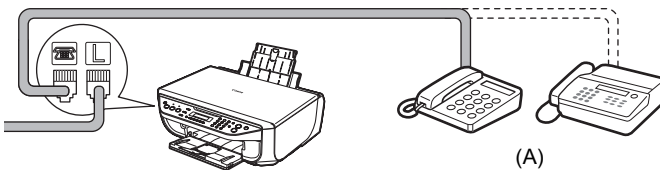

(A) Telephone or Answering machine

Important

Do not connect the machine and external devices in parallel to the same telephone line using a splitter (A). The machine may not operate properly.

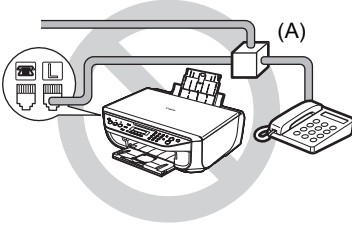

● **Connecting a Telephone or Answering Machine via a Computer**

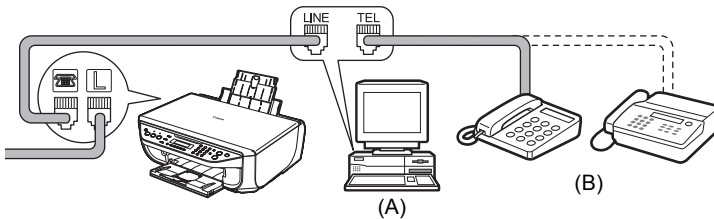

(A) Computer

(B) Telephone or Answering machine

Users in the UK

If the connector of the external device cannot be connected to the jack on the machine, you will need to purchase a B.T. adapter to connect as follows:

Connect the external device line to the B.T. adapter, then connect the B.T. adapter to the  jack.

■ Methods of Connecting the Various Lines

The following are some basic connection schemes that apply when you are connecting to a non-analog telephone line. These are examples and are not guaranteed to suit every connecting conditions. For details, refer to the instruction manual supplied with the network device (control devices such as an xDSL modem, terminal adapter, or dial-up router) you are connecting to this machine.

● Connecting to an xDSL

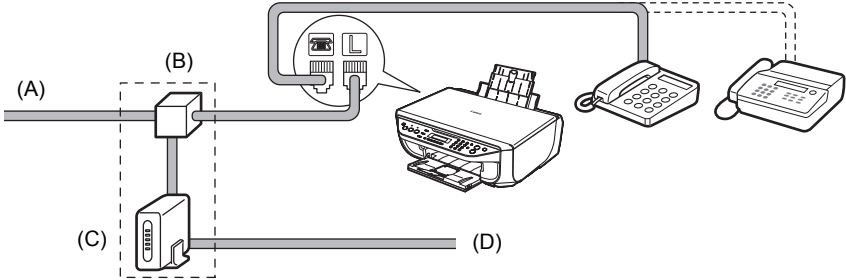

- (A) Digital Subscriber Line
(B) Splitter
(C) xDSL modem (splitter may be built-in to the modem)
(D) Computer

● Connecting to an ISDN Line

For details on ISDN connection and settings, see the manuals supplied with your terminal adapter or dial-up router.

■ Setting the Telephone Line Type

Before using the machine, make sure you set the correct telephone line type for your telephone line. If you are unsure of your telephone line type, contact your telephone company. For ISDN (Integrated Services Digital Network) or xDSL (Digital Subscriber Line) connections, contact the telephone company or service provider to confirm your line type.

📖 Note

- This setting may not be available depending on the country or region of purchase.
 - You can print the User's data list to check the current setting. See "Printing the User's Data List" on page 56.
-

- 1 Press the **FAX** button, then press the **Menu** button.
- 2 Press the ◀ or ▶ button to select **USER SETTINGS**, then press the **OK** button.

```
USER SETTINGS
DATE/TIME SETTING▶
```

- 3 Press the ◀ or ▶ button to select **TEL LINE TYPE**, then press the **OK** button.

```
TEL LINE TYPE
◀ *TOUCH TONE
```

4 Press the ◀ or ▶ button to select the telephone line type, then press the **OK** button.

ROTARY PULSE: Suitable for pulse dialing.

TOUCH TONE: Suitable for tone dialing.

 **Note**

You cannot use **ROTARY PULSE** depending on the country or region of purchase.

5 Press the **Stop/Reset** button.

Registering Sender Information

A fax you receive may have information, such as the sender's name or the company name, the sender's phone or fax number, and the date and time of the transmission, printed in small type at the top of each page. Such sender information is called Transmit Terminal Identification, or TTI.

You can register your TTI in this machine, so that the recipient of your fax will know who sent it, and when it was sent.

Below is an example of how your sender information would be printed on a fax sent from the machine:

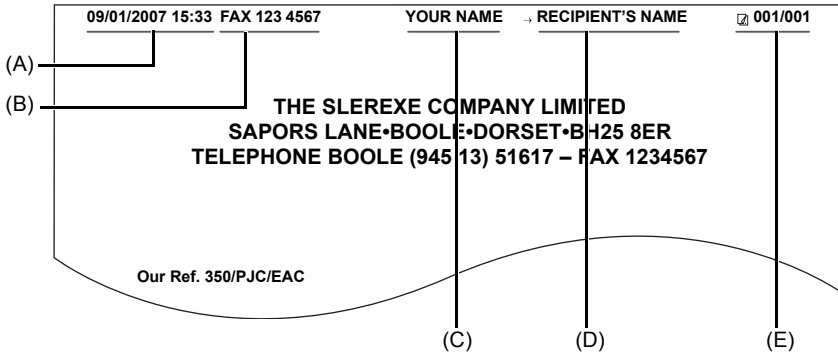

(A) Date and time of transmission

(B) Your fax/telephone number

You can select **FAX** or **TEL** to be printed before the number. See “TX TERMINAL ID” in the *User’s Guide* on-screen manual.

(C) Your name

(D) Prints the name of the destination when sending from coded speed dialing.

(E) Page number

Note

- When sending black & white faxes, you can set the sender information to print inside or outside the image area. Refer to “TX TERMINAL ID” in “FAX SETTINGS” of the *User’s Guide* on-screen manual.
 - For color sending, the sender information is printed inside the print area and the recipient’s name is not printed.
 - You can enter the sender information from the Operation Panel. See “Registering Your Fax/Telephone Number and Name (Sender Information)” on page 34.
 - Three date display formats are available: **YYYY/MM/DD**, **MM/DD/YYYY**, and **DD/MM/YYYY**. For details on the date format settings, refer to “DATE DISPLAY” in “FAX SETTINGS” of the *User’s Guide* on-screen manual.
-

■ Guidelines for Entering Numbers, Letters, and Symbols

The following characters are assigned to the Numeric buttons.

Button	Uppercase letter mode	Lowercase letter mode	Number mode
1			1
2	ABCÄÅÄÄÄÄÄÆÇ	abcääääääääæç	2
3	DEFËËËËË	defëëëëë	3
4	GHIÏÏÏÏÏ	ghiïïïïï	4
5	JKL	jkl	5
6	MNOÑÕÖÖÖÖÖ	mnoñõööööö	6
7	PQRSP	pqrsp	7
8	TUVÛÛÛÛÛ	tuvûûûûû	8
9	WXYZÝ	wxyzý	9
0			0
#	-.SP* *#!",;:^`_=/!?'\$@%&+()[]{}<>		
*	Press the * button to switch to uppercase letter mode (:A), lowercase letter mode (:a), or number mode (:1).		

* SP indicates a space.

Follow the procedure below to enter letters and numbers when you register names and fax/ phone numbers for the sender information or a coded speed dial.

- 1 Press the * button to switch to uppercase letter mode (:A), lowercase letter mode (:a), or number mode (:1).

You can see what mode you are in by the character displayed on the top right corner of the LCD.

NAME	: A
------	-----

- 2 Press the Numeric buttons to enter a character.

Press the button repeatedly until the character you want appears.

- **To enter a character that is assigned to the same button as the previous entry:**

(1) Press the Numeric button, press the ► button, then press the same Numeric button again.

- **To enter a space:**

(1) Press the ► button two times.
In number mode, press the ► button once.

- **To delete a character:**

(1) Press the ◀ button.

- **To delete an entire entry:**

(1) Press and hold the ◀ button.

■ Entering the Date and Time

Note

- When the machine is connected to a computer with the MP Drivers installed, the date and time setting will be copied from the computer to the machine. As long as the date and time is set accurately on your computer, you do not need to set it on the machine.
 - If you disconnect the power cord or when there is a power failure, the date and time setting on the machine will be reset. When you connect the machine to a computer with the MP Drivers installed, the setting will be copied to the machine once again.
-

- 1 Press the **FAX** button, then press the **Menu** button.
- 2 Press the ◀ or ▶ button to select **USER SETTINGS**, then press the **OK** button two times.

DATE/TIME SETTING	
02/15/2007	18:46

- 3 Press the Numeric buttons to enter the date and time (in 24-hour format), then press the **OK** button.
Enter only the last two digits of the year.
-

Note

- If you misentered the date and time, press the ◀ or ▶ button to move the cursor under the number to enter the correct number.
 - Three formats of date are available. For details on the date format settings, refer to “DATE DISPLAY” in “FAX SETTINGS” of the *User’s Guide* on-screen manual.
-

- 4 Press the **Stop/Reset** button.

■ Registering Your Fax/Telephone Number and Name (Sender Information)

- 1 Press the **FAX** button, then press the **Menu** button.
- 2 Press the ◀ or ▶ button to select **USER SETTINGS**, then press the **OK** button.
- 3 Press the ◀ or ▶ button to select **UNIT TEL NUMBER**, then press the **OK** button.

UNIT TEL NUMBER
TEL=

- 4 Press the Numeric buttons to enter your fax/telephone number (max. 20 digits, including spaces), then press the **OK** button.

To enter a plus sign (+) before the number, press the # button.

USER SETTINGS
◀ UNIT NAME ▶

Note

For details on how to enter or delete characters, see “Guidelines for Entering Numbers, Letters, and Symbols” on page 33.

- 5 Press the **OK** button.

UNIT NAME : A

- 6 Press the Numeric buttons to enter your name (max. 24 characters, including spaces), then press the **OK** button.

 **Note**

For details on how to enter or delete characters, see "Guidelines for Entering Numbers, Letters, and Symbols" on page 33.

- 7 Press the **Stop/Reset** button.

 **Note**

You can print the User's data list to confirm the sender information you have registered. See "User's Data List" on page 56.

■ Setting Daylight Saving Time (Summer Time)

Some countries adopt the daylight saving time (summer time) system that shifts the clock time forward or back at certain periods of the year.

You can set the machine to automatically change the time by registering the day and time that daylight saving (summer time) begins and ends.

 **Note**

This setting may not be available depending on the country or region of purchase.

- 1 Press the **FAX** button, then press the **Menu** button.
- 2 Press the ◀ or ▶ button to select **USER SETTINGS**, then press the **OK** button.
- 3 Press the ◀ or ▶ button to select **SUMMER TIME SET**, then press the **OK** button.

SUMMER TIME SET
*ON ▶

- 4 Press the ◀ or ▶ button to select **ON** or **OFF**, then press the **OK** button.
- If you select **OFF**, go to step 7.
 - If you select **ON**, go to step 5.

- 5 Set the date and time that summer time stars.

- (1) Press the **OK** button two times.

SET MONTH
◀ *MARCH ▶

- (2) Press the ◀ or ▶ button to select the month when summer time starts, then press the **OK** button two times.

SET WEEK
◀ *LAST WEEK

- (3) Press the ◀ or ▶ button to select the week when summer time starts, then press the **OK** button two times.

SET DAY OF WEEK
*SUNDAY ▶

- (4) Press the ◀ or ▶ button to select the day of the week when summer time starts, then press the **OK** button two times.

SET SHIFT TIME
01 : 00

- (5) Press the Numeric buttons to enter the time (in 24-hour format) when summer time starts, then press the **OK** button three times. Precede single digit with a zero.

SET MONTH
◀ *OCTOBER ▶

6 Set the date and time that summer time ends.

- (1) Press the ◀ or ▶ button to select the month when summer time ends, then press the **OK** button two times.

SET WEEK
◀ *LAST WEEK

- (2) Press the ◀ or ▶ button to select the week when summer time ends, then press the **OK** button two times.

SET DAY OF WEEK
*SUNDAY ▶

- (3) Press the ◀ or ▶ button to select the day of the week when summer time ends, then press the **OK** button two times.

SET SHIFT TIME
02 : 00

- (4) Press the Numeric buttons to enter the time (in 24-hour format) when summer time ends, then press the **OK** button. Precede single digit with a zero.

7 Press the **Stop/Reset** button.

Registering the Destination

■ Registering Coded Speed Dialing

Coded speed dialing allows you to dial fax/telephone numbers by simply pressing a few buttons. To dial the number, press the **Coded Dial** button, enter the two-digit code assigned to that number.

Before you can use coded speed dialing, you need to register the recipient's fax/telephone numbers for coded speed dialing.

Note

For a list of the recipients you have registered, print the coded speed dialing list. See "Printing a List of the Registered Destination" on page 38.

- 1 Press the **FAX** button, then press the **Menu** button.
- 2 Press the ◀ or ▶ button to select **CODED DIAL REGIST**, then press the **OK** button.

CODED DIAL REGIST
*00=

- 3 Press the ◀ or ▶ button to select a coded speed dialing code (00 - 19), then press the **OK** button two times.

TEL NUMBER
TEL=

- 4 Press the Numeric buttons to enter the fax/telephone number you want to register (max. 60 digits (40 digits for Korea), including spaces), then press the **OK** button two times.

NAME : A

Note

- For details on how to enter or delete numbers, see "Guidelines for Entering Numbers, Letters, and Symbols" on page 33.
 - Press the **Redial/Pause** button to enter a pause.
 - Press the * button to enter a tone.
-

- 5 Press the Numeric buttons to enter a name for the coded speed dialing code (max. 16 characters, including spaces), then press the **OK** button.

The **CODED DIAL REGIST** screen is displayed to enter the next number.

- If you continue registering coded speed dialing, repeat the procedure from step 3.
 - If not, go to step 6.
-

Note

For details on how to enter or delete characters, see "Guidelines for Entering Numbers, Letters, and Symbols" on page 33.

6 Press the **Stop/Reset** button.

■ Changing or Deleting a Registered Information

● To Change a Registered Number or Name:

1 Follow the procedures from step 1 to 3 under “Registering Coded Speed Dialing” on page 37.

2 Press and hold the ◀ button to delete the registered number.

3 Press the Numeric buttons to enter the new number (max. 60 digits (40 digits for Korea), including spaces), then press the **OK** button two times.

4 Press and hold the ◀ button to delete the registered name.

5 Press the Numeric buttons to enter the new name, then press the **OK** button.

6 Press the **Stop/Reset** button.

● To Delete an Entire Entry:

1 Follow the procedures from step 1 to 3 under “Registering Coded Speed Dialing” on page 37.

2 Press and hold the ◀ button to delete the registered number, then press the **OK** button.

3 Press the **Stop/Reset** button.

The name will automatically be deleted when you delete the number.

■ Printing a List of the Registered Destination

You can print a list of the recipients registered for coded speed dialing. You may want to keep the list near the machine to refer to it when dialing.

1 Press the **FAX** button, then press the **Menu** button.

2 Press the ◀ or ▶ button to select **PRNT REPORT/LIST**, then press the **OK** button.

```
PRNT REPORT/LIST
  ACTIVITY REPORT ▶
```

3 Press the ◀ or ▶ button to select **SPEED DIAL LIST**.

```
PRNT REPORT/LIST
◀ SPEED DIAL LIST ▶
```

4 Press the **OK** button.

```
PRINT BY NAME?
< YES >          NO
```

- 5** Press the ◀ or ▶ button to select the sorting way, then press the **OK** button.
- YES:** Prints the list with the destination name (DESTINATION ID) in alphabetical order.
- NO:** Prints the list with the registered entries in numerical order.

Sending Faxes

■ Flow of Sending Faxes

The operation flow of sending faxes is as follows.

Step 1

Load the original to send on the Platen Glass.

See “Loading Original Documents” on page 8.

Step 2

Adjust the fax quality and scan contrast.

See “Adjusting the Scan Contrast or the Image Quality (Fax Resolution)” on page 41.

Step 3

Dial the recipient's number.

Step 4

Send Faxes.

- (1) Press the **Color** or **Black** button.

If you have two or more pages of the original, load the next page on the Platen Glass and press the **Color** or **Black** button.

- (2) After scanning all pages of the original, press the **OK** button to send the fax.

■ Before Sending Faxes

● Adjusting the Scan Contrast or the Image Quality (Fax Resolution)

● Adjusting the Scan Contrast

Contrast is the degree of difference between light and dark. Increasing the scan contrast setting further blackens dark areas and whitens bright areas, whereas decreasing the contrast setting reduces the difference between bright and dark areas. You can adjust the contrast among three contrast levels.

- (1) Press the **FAX** button, then press the **FAX Quality** button.
- (2) Press the ◀ or ▶ button to select the contrast.



Pressing the ◀ button decreases the contrast, and pressing the ▶ button increases the contrast.

- (3) Press the **OK** button.

● Adjusting the Image Quality (Fax Resolution)

You can adjust the image quality (fax resolution) of the document you send. The higher you set the image quality setting, the better the output quality will be at the other end, but the longer it will take for the transmission. Adjust the image quality according to the type of document you are sending.

- (1) Press the **FAX** button, then press the **FAX Quality** button two times.
- (2) Press the ◀ or ▶ button to select the resolution.

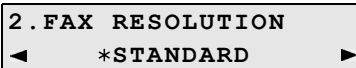

STANDARD: Suitable for text-only documents.

FINE: Suitable for fine-print documents.

PHOTO: Suitable for photographs.

- (3) Press the **OK** button.

■ Sending Faxes

This section describes methods of sending faxes and dialing functions of the machine.

- Memory sending
- Dialing the coded speed dial
- Redialing

● Sending Faxes (Memory Sending)

1 Prepare for faxing.

- (1) Turn on the machine.
- (2) Load the original on the Platen Glass.

Note

For details on the types and conditions of originals which you can fax, see “Loading Original Documents” on page 8.

- (3) Press the **FAX** button.
- (4) Adjust fax settings as necessary.
See “Adjusting the Scan Contrast or the Image Quality (Fax Resolution)” on page 41.

2 Start faxing.

- (1) Dial the recipient's number using the Numeric buttons or coded speed dialing.

Note

For details on how to use coded speed dialing, see “Dialing the Coded Speed Dial” on page 43.

- (2) Press the **Color** button for color sending, or the **Black** button for black & white sending.
- (3) When the following message is displayed, load the next page on the Platen Glass.

SCAN NEXT	→ [START]
TRANSMIT	→ [OK]

If you have only one page of document to scan, go to step (6).

- (4) Press the same button as you pressed in step (2).
- (5) Repeat steps (3) and (4) to scan in all pages of the document.
- (6) Press the **OK** button.

Important

Color sending is available only when the recipient's fax machine supports color faxing.

Note

- To cancel sending a fax, press the **Stop/Reset** button. To cancel sending a fax while it is being sent, press the **Stop/Reset** button, then follow the instructions on the LCD.
 - In case the machine was not able to send a fax, such as when the recipient's line was busy, the machine is equipped with the function to automatically redial the number after a specified interval. Automatic redialing is enabled by default. See “Automatic Redialing” on page 43. To cancel automatic redialing, wait until the machine starts redialing, press the **Stop/Reset** button, then follow the instructions on the LCD.
-

● Dialing the Coded Speed Dial

- 1 Prepare for faxing.
See "Prepare for faxing." on page 42.
- 2 Press the **Coded Dial** button.
- 3 Press the Numeric buttons to enter the two-digit code (00 - 19) assigned to the number you want to dial.
- 4 Press the **Color** button for color sending, or the **Black** button for black & white sending.

Important

Color sending is available only when the recipient's fax machine supports color faxing.

Note

To cancel sending a fax, press the **Stop/Reset** button. To cancel sending a fax while it is being sent, press the **Stop/Reset** button, then follow the instructions on the LCD.

● Redialing

There are two methods of redialing: Automatic redialing and Manual redialing. Automatic redialing is enabled by default.

● Automatic Redialing

When using memory sending to send a document and the recipient's line is busy, the machine will redial the number after a specified interval.

You can customize the following automatic redialing settings:

- Whether or not the machine redials automatically
- The number of times the machine redials (1 to 10 times)
- The time interval between redials (1 to 99 minutes)

To change the automatic redialing settings, change the **AUTO REDIAL** settings in **TX SETTINGS** under **FAX SETTINGS**.

Note

- The range of values you can set for the automatic redialing settings varies depending on the country or region of purchase.
 - To cancel automatic redialing while redialing is in progress, press the **Stop/Reset** button, then follow the instructions on the LCD.
 - To cancel automatic redialing when redialing is standing by, delete the unsent document from the machine's memory. For details, see "Printing or Deleting a Document in Memory" on page 52.
-

● Manual Redialing

To redial the fax number last dialed with the Numeric buttons, press the **Redial/Pause** button.

Note

- For details on sending faxes, see "Sending Faxes (Memory Sending)" on page 42.
 - To cancel manual redialing, press the **Stop/Reset** button.
-

Using Other Useful Sending Functions

■ Sending from Your Computer (Windows Only)

If the machine is connected to a computer, you can send faxes using the fax driver from any application software that has a printing function. For details, refer to the *FAX Driver Guide* on-screen manual.

■ Sending/Receiving Using ECM

This machine is set to send/receive faxes in ECM (Error Correction Mode). ECM automatically corrects errors caused by connection troubles, cross-checking the sending and receiving conditions at the sending and receiving ends.

Note

- If the sender's or receiver's fax is not ECM-compatible, the fax will be sent/received in the standard mode.
 - You can disable ECM sending/receiving. Refer to "ECM TX" and "ECM RX" in "FAX SETTINGS" of the *User's Guide* on-screen manual.
 - If ECM sending/receiving is enabled, transmission speed may slow down depending on the line or connection conditions.
-

Receiving Faxes

■ Flow of Receiving Faxes

The operation flow of receiving faxes is as follows:

Step 1

Select a receive mode.

See “Selecting the Receive Mode” on page 45.

Step 2

Load A4, Letter, or Legal-sized paper.

See “Loading Paper” on page 12.

Step 3

Confirm the paper settings and adjust them as needed.

See “Changing the Print Settings” on page 50.

Important

- The machine cannot receive faxes when the power is turned off. Press the **ON/OFF** button to turn the power on.
 - To cancel receiving, press the **Stop/Reset** button and follow any instructions on the LCD.
-

■ Selecting the Receive Mode

Select the receive mode according to your needs.

- When you have a dedicated telephone line for fax use only:
Select **FAX ONLY MODE**.
 - When you are using a single telephone line for faxes and voice calls:
If you receive mainly voice calls and sometimes faxes, select **TEL PRIORITY MODE**.
If you receive mainly faxes and sometimes voice calls, select **FAX PRIORITY MODE**.
 - When you subscribe to a ring pattern detection service provided by your telephone company. (Not available depending on the country or region of purchase.):
Select **DRPD** or **NETWORK SWITCH**.
-

Note

If you do not have a dedicated phone line for fax use only, you need to connect a telephone or an answering machine to the External device jack of this machine.

- **If You Want to Receive Only Faxes Automatically with the Machine, or Have a Dedicated Telephone Line for Fax Use Only:**
Select **FAX ONLY MODE**.

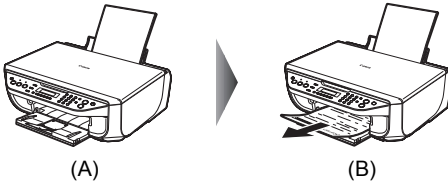

- (A) Incoming call
- (B) Receives faxes automatically.

Note

You will not be able to answer the call.

- **If You Are Using a Single Telephone Line for Faxes and Voice Calls and Use Voice Calls More Frequently:**
Select **TEL PRIORITY MODE**.

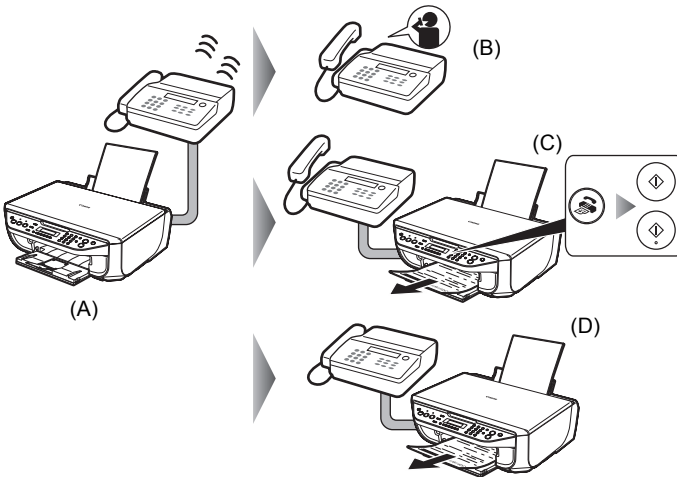

- (A) Incoming call
- (B) Voice call: The telephone will ring. Pick up the handset to answer the call.
- (C) Fax: The telephone will ring. If you pick up the handset when receiving a fax, press the **FAX** button, then press the **Color** or **Black** button.

Note

If the machine is located away from the telephone, pick up the handset and dial 25 (the remote receiving ID) to receive faxes (remote reception). See "Remote Receiving" on page 51.

- (D) When the answering machine responds:
If it is a voice call, the answering machine responds to the call.
If it is a fax call, the machine receives the fax automatically.

 **Note**

- Set your answering machine to answering mode and adjust it as follows:
 - The entire message should be no longer than 15 seconds.
 - In the message, tell your callers how to send a fax.
 - The machine can be set to receive faxes automatically after the telephone rings for a specified length of time. Set **MAN/AUTO SWITCH** in **RX SETTINGS** under **FAX SETTINGS** to **ON**, and then specify the automatic reception start time. Refer to “MAN/AUTO SWITCH” in “FAX SETTINGS” of the *User’s Guide* on-screen manual.
 - If you have subscribed to Duplex Ringing service in Hong Kong, the machine will receive faxes automatically even if you set the receiving mode of the machine to **TEL PRIORITY MODE**.
-

● **If You Are Using a Single Telephone Line for Faxes and Voice Calls and Want to Receive Faxes Automatically:**

Select **FAX PRIORITY MODE**.

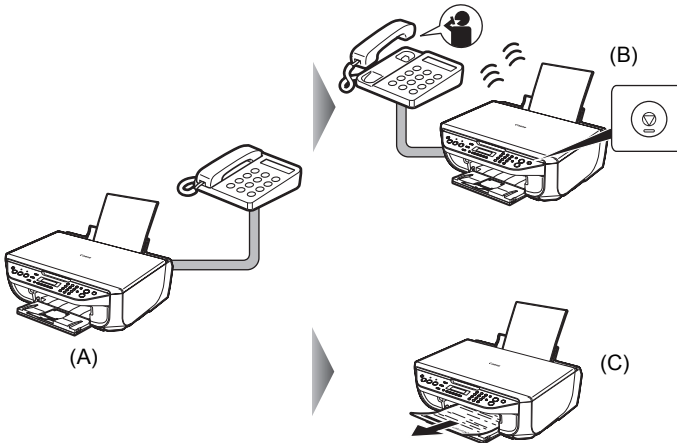

(A) Incoming call

(B) Voice call: The machine will ring. Pick up the handset, then press the **Stop/Reset** button to answer the call.

 **Important**

When answering a voice call, be sure to pick up the handset before pressing the **Stop/Reset** button. If you press the **Stop/Reset** button before picking up the handset, the telephone call will be disconnected.

(C) Fax: The machine receives faxes automatically.

 **Note**

The following settings can be modified to control how the machine handles incoming calls. Specify the **FAX PRIORITY MODE** settings in **RX SETTINGS** under **FAX SETTINGS**. Refer to “FAX PRIORITY MODE” in “FAX SETTINGS” of the *User’s Guide* on-screen manual.

- The time the machine takes to determine whether a call is a fax or a voice call
 - The time the machine rings when the call was a voice call
 - Whether or not the machine receives the fax after the specified ring time has elapsed
-

● **If You Subscribe to a Distinctive Ring Pattern Detection (DRPD) Service with Your Telephone Company (US and Canada only):**

Select **DRPD**.

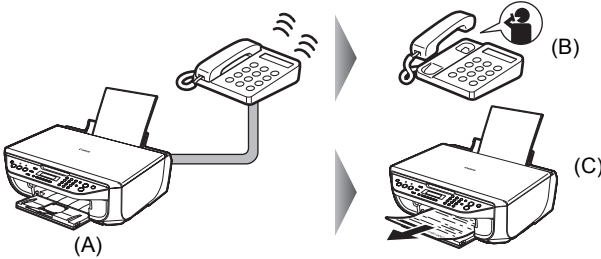

(A) Incoming call

(B) Voice call: The telephone will ring. Pick up the handset to answer the call.

(C) Fax: The fax is received automatically when the machine detects the registered fax ring pattern.

● **Setting the Ring Pattern**

Your telephone company will assign a distinctive ring pattern to each number when you order the DRPD service. Set the fax ring pattern that matches the pattern assigned by the telephone company.

 **Note**

For details on the setting the ring pattern of DRPD service, refer to “DRPD:FAX RNG PAT” in “FAX SETTINGS” of the *User’s Guide* on-screen manual.

● **If You Want the Machine to Automatically Switch between Fax and Voice Calls by the Call Ring Patterns (Network Switch):**

Select **NETWORK SWITCH***.

* This setting may not be available depending on the country or region of purchase.

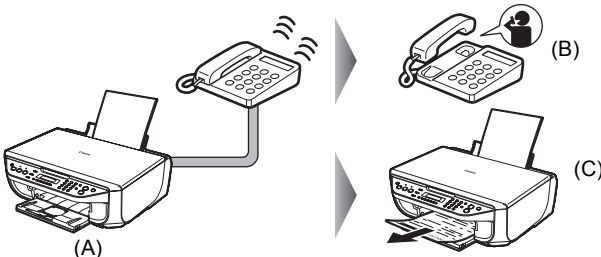

(A) Incoming call

(B) Voice call: The telephone will ring. Pick up the handset to answer the call.

(C) Fax: The fax is received automatically when the machine detects the registered fax ring pattern.

 **Note**

- The name of this service varies depending upon a country.
 - To use this feature, you need to subscribe to a compatible service provided by your telephone company. Contact your telephone company for details.
-

■ Setting the Receive Mode

- 1 Press the **FAX** button, then press the **Menu** button.
- 2 Press the **OK** button.

```
RECEIVE MODE SET
*FAX PRIORITY MODE▶
```

- 3 Press the ◀ or ▶ button to select the receive mode.

Note

For details on the receive modes, see "Selecting the Receive Mode" on page 45.

- 4 Press the **OK** button.

The receive mode will be displayed on the bottom left of the LCD.

```
02/15/2007 WED 06:11
FAX 1ST          STANDARD
```

(A)

(A) Receive mode

FAXONLY:The receive mode is **FAX ONLY MODE**.

TEL 1ST: The receive mode is **TEL PRIORITY MODE**.

FAX 1ST: The receive mode is **FAX PRIORITY MODE**.

DRPD: The receive mode is **DRPD**.

NET SW.: The receive mode is **NETWORK SWITCH**.

■ Changing the Print Settings

Load A4, Letter, or Legal-sized plain paper in the Rear Tray to print the fax.

Important

If paper of size other than A4, Letter or Legal is loaded, the received faxes will not be printed and **"RECEIVED IN MEMORY"** is displayed. Replace the paper loaded with A4, Letter or Legal sized paper, then press the **OK** button.

Note

If the sender sends a document that is larger than Letter-size, such as 11" x17" or Legal-size, the sender's machine may send the fax automatically shrunk or divided, or send only a part of the original.

- 1 Press the **FAX** button, then press the **Settings** button.

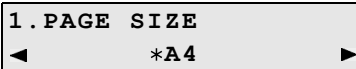

- 2 Press the ◀ or ▶ button to select the page size from **A4, 8.5" x 11"**, or **8.5 x 14**.
- 3 Press the **OK** button.
- 4 Press the ◀ or ▶ button to select **PLAIN PAPER**.

Note

If the paper is set to a size other than **A4, 8.5" x 11"**, or **8.5 x 14**, or if it is set to a type other than **PLAIN PAPER**, the received faxes will not be printed and **"RECEIVED IN MEMORY"** is displayed. Correct the paper size and type, and then press the **OK** button.

- 5 Press the **OK** button.

■ Setting the Number of Rings for Fax Calls

When **FAX ONLY MODE**, **FAX PRIORITY MODE**, or **DRPD** is selected as the receive mode, you can specify the number of rings for fax calls in **RING COUNT** in **RX SETTINGS** under **FAX SETTINGS**.

Using Other Useful Receiving Functions

■ Memory Receiving

If the machine receives a fax under one of the following conditions, the machine will not be able to print the received fax and will store it in its memory. "**RECEIVED IN MEMORY**" is displayed in fax mode. When the problem is resolved as described, the fax stored in memory is printed automatically.

- Ink is low or has run out while receiving a fax: replace the FINE Cartridge.
- Paper size/type setting is incorrect: correct the paper size/type setting.
- Paper has run out while receiving a fax: load the paper and press the **OK** button.
- Output Tray is closed: open it.
- **OFF** is selected for **AUTO PRINT RX**: select **ON**.
- You pressed the **Stop/Reset** button to cancel printing of a fax: press the **FAX** button.

Important

- The machine can store up to approximately 50 pages* of faxes in memory.
 - If the memory becomes full, the machine cannot receive any more faxes. Print or delete the documents stored in memory, and then contact the sender and have him/her resend them.
- * When using ITU-T No.1 chart (Standard mode)
-

■ Remote Receiving

If the machine is located away from the telephone, pick up the handset and dial 25 (the remote receiving ID) to receive faxes (remote reception).

- If you use a rotary pulse line, temporarily switch your telephone to tone dialing. For details on how to switch to tone dialing, see the instruction manual supplied with your telephone.
- If you have an answering machine connected to the machine that can carry out remote control operations, the security code for this function may be the same as the remote receiving ID. In this case, change the remote reception ID in **REMOTE RX ID** in **REMOTE RX** in **RX SETTINGS** under **FAX SETTINGS**.

Remote reception can be disabled. Refer to "REMOTE RX" in "FAX SETTINGS" of the *User's Guide* on-screen manual.

Document Stored in Memory

Important

If you disconnect the power cord, all the documents stored in memory are deleted. Send or print necessary documents before disconnecting the power cord.

Note

When confirming, printing, or deleting a document stored in memory, you specify it by its transaction number. If you do not know the transaction number for your target document, print the list of documents first.

■ Printing a List of Documents in Memory

The machine can print a list of documents stored in memory (the memory list) showing the transaction number (TX/RX NO.), transaction mode, recipient, number of pages, date, and transmission time of each document. When printing or deleting documents in memory, specify a document by its transaction number.

- 1 Press the **FAX** button, then press the **Menu** button.
- 2 Press the ◀ or ▶ button to select **MEMORY REFERENCE**.
- 3 Press the **OK** button two times.
The memory list is printed.

Note

- If there are no documents stored in memory, “**NO DOC. IN MEMORY**” is displayed, and the machine returns to the previous screen.
 - In step 2, you can also select **PRINT REPORT/LIST** (see “Summary of Reports and Lists” on page 55) and then **MEMORY LIST** to print the memory list.
 - If you have canceled receiving a fax in progress by pressing the **Stop/Reset** button, the fax may be printed after the memory list.
-

■ Printing or Deleting a Document in Memory

- 1 Press the **FAX** button, then press the **Menu** button.
- 2 Press the ◀ or ▶ button to select **MEMORY REFERENCE**.
- 3 Press the **OK** button.

4 Press the ◀ or ▶ button to select **PRINT DOCUMENT** or **DELETE DOCUMENT**.

● **If you select PRINT DOCUMENT:**

- (1) Press the **OK** button.
- (2) Press the ◀ or ▶ button to select the transaction number (TX/RX NO.) of the document you want to print, or enter the number by pressing the Numeric buttons.
If you are unsure of the transaction number, print the memory list. See "Printing a List of Documents in Memory" on page 52.
- (3) Press the **OK** button.
- (4) Press the ◀ button to select **YES** to print the first page only, or press the ▶ button to select **NO** to print all pages of the document.
- (5) Press the **OK** button.

 **Note**

If you have canceled receiving a fax in progress by pressing the **Stop/Reset** button, the fax may be printed after the selected document.

- (6) To print another document, return to step (2), or to finish printing, go to step 5.

● **If you select DELETE DOCUMENT:**

- (1) Press the **OK** button.
- (2) Press the ◀ or ▶ button to select the transaction number (TX/RX NO.) of the document you want to delete, or enter the number by pressing the Numeric buttons.
- (3) Press the **OK** button.
- (4) Press the ◀ button to select **YES** to delete document, or press the ▶ button to select **NO** not to delete the document.
- (5) Press the **OK** button.
- (6) To delete another document, return to step (2), or to finish deleting, go to step 5.

5 Press the **Stop/Reset** button.

■ Checking a Document's Details in Memory

If the machine was not able to print a received fax when the machine is in one of the following situations, the fax is automatically stored in memory.

- If ink is low or has run out while receiving a fax
- If the paper size/type setting is incorrect
- If the paper run out while receiving a fax
- If the Output Tray is closed
- If **OFF** is selected for **AUTO PRINT RX**
- If you pressed the **Stop/Reset** button to cancel printing of a fax

When selecting a document in memory to be printed or deleted, you can check its details on the LCD as follows:

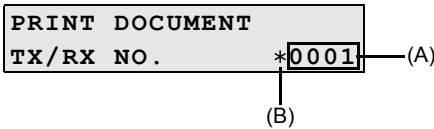

(A) Transaction number (TX/RX NO.)

- A transaction number from 0001 to 4999 indicates a document being sent.
- A transaction number from 5001 to 9999 indicates a document being received.

(B) Marks before the transaction number

- No mark indicates a black & white document.
- <*> indicates a color document.
- <#> indicates a black & white document being sent or printed.
- <&> indicates a color document being sent or printed.

Displaying Details of the Transaction

Press the * or # button to display the details (e.g. transaction number, transaction time and fax number).

Note

If you are unsure of the transaction number, print the memory list. See "Printing a List of Documents in Memory" on page 52.

Summary of Reports and Lists

The table below shows the reports and lists that can be printed from the machine. Refer to the pages indicated for more details.

Report Or List	Description
Activity report	Shows recent fax transactions performed by your machine. See "Activity Report" on page 55.
Coded speed dial list	Lists the numbers and names registered for coded speed dialing. See "Printing a List of the Registered Destination" on page 38.
User's data list	Lists the current settings of the machine and the registered sender information. See "User's Data List" on page 56.
Memory list	Lists the documents currently stored in the machine's memory. See "Document Stored in Memory" on page 52.
TX (Transmission) report	Confirms whether a transmission was completed successfully. If enabled, prints after each fax transmission. See "TX Report" on page 56.
RX (Reception) report	Confirms whether a reception was completed successfully. If enabled, prints after each fax reception. See "RX Report" on page 56.

■ Activity Report

Prints the history of sent and received faxes. The machine is factory-set to print an Activity report after every 20 transactions. You can also disable automatic printing of this report, or print it manually.

Note

For details on the Activity report setting, refer to "ACTIVITY REPORT" in "FAX SETTINGS" of the *User's Guide* on-screen manual.

● Printing the Activity Report Manually

- 1 Press the **FAX** button, then press the **Menu** button.
- 2 Press the ◀ or ▶ button to select **PRNT REPORT/LIST**, then press the **OK** button.
- 3 Press the ◀ or ▶ button to select **ACTIVITY REPORT**, then press the **OK** button.
The Activity report is printed.

■ User's Data List

The User's data list enables you to confirm the current settings of the machine as well as the registered sender information. See "Registering Sender Information" on page 32.

● Printing the User's Data List

- 1 Press the **FAX** button, then press the **Menu** button.
- 2 Press the ◀ or ▶ button to select **PRNT REPORT/LIST**, then press the **OK** button.
- 3 Press the ◀ or ▶ button to select **USER'S DATA LIST**, then press the **OK** button.
The User's data list is printed.

■ Other Lists

● TX Report

The machine can print a TX (transmission) report after sending a document, confirming whether the transmission was completed successfully. You can set the machine to print every time it sends a document, or only when an error occurs. Alternatively, you can disable printing of the report.

Note

- For details on the TX report setting, refer to "TX REPORT" in "FAX SETTINGS" of the *User's Guide* on-screen manual.
 - The default setting is **PRINT ERROR ONLY**.
-

● RX Report

The machine can print an RX (reception) report after receiving a document, confirming whether the reception was completed successfully. You can set the machine to print every time it receives a document, or only when an error occurs. Alternatively, you can disable printing of the report.

Note

- For details on the RX report setting, refer to "RX REPORT" in "FAX SETTINGS" of the *User's Guide* on-screen manual.
 - The default setting is **DO NOT PRINT**.
-

Routine Maintenance

When Printing Becomes Faint or Colors Are Incorrect

When printing becomes faint or colors are incorrect, the print head nozzles on FINE Cartridges are probably clogged. Print the nozzle check pattern to confirm the condition of the nozzles and then perform Print Head Cleaning.

If print results are not satisfactory, performing Print Head Alignment may improve print quality.

Note

Before performing maintenance

- Make sure that a FINE Cartridge has not run out of ink. See “Getting the Ink Status Information” on page 64.
 - Make sure that a FINE Cartridge is installed properly. See “Replacing FINE Cartridges” on page 67.
 - Make sure that the orange protective tape is removed from the bottom of a FINE Cartridge.
 - If the error message is displayed on the LCD, see “An Error Message Is Displayed on the LCD” on page 76.
 - Increase the **Print Quality** setting in the printer driver settings.
Refer to the *PC Printing Guide* on-screen manual.
-

Step 1

See “Printing the Nozzle Check Pattern” on page 58.

If lines are missing or if white streaks appear



Step 2

See “Print Head Cleaning” on page 60.

If the problem is not resolved after performing
Print Head Cleaning twice



Step 3

See “Print Head Deep Cleaning” on page 61.

If the problem is not resolved after performing Print
Head Deep Cleaning twice



Step 4

See “Replacing a FINE Cartridge” on page 64.



After cleaning the Print
Head, print and examine
the nozzle check pattern.

Note

If the straight line is misaligned or the Print Head position is misaligned, align the Print Head position. See “Aligning the Print Head” on page 62.

Printing the Nozzle Check Pattern

Print the nozzle check pattern to determine whether the ink ejects properly from the print head nozzles.

- 1** Make sure that the machine is turned on, then load a sheet of A4 or Letter-sized plain paper in the Rear Tray.
- 2** Open the Paper Output Tray, then set the Paper Thickness Lever.
 - (1) Put your finger in the rounded indent beside the Paper Output Tray and open it gently.
 - (2) Open up and set the Output Tray Extension completely by pressing down the hollow on its front side.
 - (3) Set the Paper Thickness Lever to the left. For details on the Paper Thickness Lever, refer to “Inside” in “Main Components” of the *User’s Guide* on-screen manual.
- 3** Print the nozzle check pattern.
 - (1) Press the **Menu** button repeatedly until **MAINTENANCE** appears.
 - (2) Press the ◀ or ▶ button to select **NOZZLE CHECK**, then press the **OK** button.



The machine prints a nozzle check pattern.

- 4** Examine the pattern and take the appropriate action.
See “Examining the Nozzle Check Pattern” on page 59.

Examining the Nozzle Check Pattern

Examine the nozzle check pattern, and perform cleaning if necessary.

Note

The nozzle check pattern will not be printed correctly if there is not enough ink. Replace the FINE Cartridge if the remaining amount of ink is insufficient. See “Replacing a FINE Cartridge” on page 64.

- 1 Check the nozzle check pattern you printed.

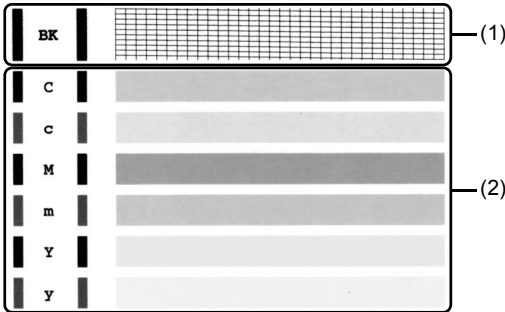

- (1) If lines of this pattern are missing, the print head nozzles need cleaning.
Example: When lines are missing (Black ink)

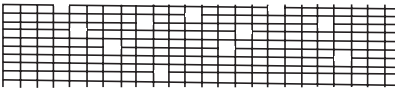

- (2) If these patterns have white streaks, the print head nozzles need cleaning.
Example: When white streaks appear (Color ink)



- 2 When cleaning is necessary, perform Print Head Cleaning.
See “Print Head Cleaning” on page 60.

Print Head Cleaning

Clean the Print Head if lines are missing or if white streaks appear in the printed nozzle check pattern. Cleaning unclogs the nozzles and restores the print head condition. Note that cleaning the Print Head causes used ink to be absorbed in the ink absorber. Cleaning the Print Head consumes ink, so perform Print Head Cleaning only when necessary.

- 1** Make sure that the machine is turned on.
- 2** Start Print Head Cleaning.
 - (1) Press the **Menu** button repeatedly until **MAINTENANCE** appears.
 - (2) Press the ◀ or ▶ button to select **CLEANING**, then press the **OK** button.



Print Head Cleaning starts.

Do not perform any other operations until Print Head Cleaning finishes. This takes about 50 seconds.

- 3** Confirm the condition of the Print Head.

When Print Head Cleaning finishes, the LCD returns to the standby mode.

Print the nozzle check pattern to check the print head condition.

See "Printing the Nozzle Check Pattern" on page 58.

Note

If the problem is not resolved after performing Print Head Cleaning twice, try Print Head Deep Cleaning. See "Print Head Deep Cleaning" on page 61.

Print Head Deep Cleaning

If print quality does not improve by standard Print Head Cleaning, try Print Head Deep Cleaning, which is a more powerful process. Note that cleaning the Print Head causes used ink to be absorbed in the ink absorber. Print Head Deep Cleaning consumes more ink than standard Print Head Cleaning, so perform this procedure only when necessary.

- 1** Make sure that the machine is turned on.
- 2** Start Print Head Deep Cleaning.
 - (1) Press the **Menu** button repeatedly until **MAINTENANCE** appears.
 - (2) Press the ◀ or ▶ button to select **DEEP CLEANING**, then press the **OK** button.



Print Head Deep Cleaning starts.

Do not perform any other operations until Print Head Deep Cleaning finishes. This takes about one minute.

- 3** Confirm the condition of the Print Head.
 - (1) Print the nozzle check pattern to check the print head condition. See "Printing the Nozzle Check Pattern" on page 58.
 - (2) If the problem is not resolved, perform Print Head Deep Cleaning again.
 - (3) If this does not solve the problem, a FINE Cartridge may have run out of ink. Replace it with a new one. See "Replacing a FINE Cartridge" on page 64.

Aligning the Print Head

If ruled lines are printed misaligned or print results are otherwise unsatisfactory, adjust the print head position.

- 1 Make sure that the machine is turned on, then load two sheets of A4 or Letter-sized plain paper in the Rear Tray.
- 2 Open the Paper Output Tray, then set the Paper Thickness Lever.
 - (1) Put your finger in the rounded indent beside the Paper Output Tray and open it gently.
 - (2) Open up and set the Output Tray Extension completely by pressing down the hollow on its front side.
 - (3) Set the Paper Thickness Lever to the left. For details on the Paper Thickness Lever, refer to "Inside" in "Main Components" of the *User's Guide* on-screen manual.
- 3 Print the print head alignment pattern.
 - (1) Press the **Menu** button repeatedly until **MAINTENANCE** appears.
 - (2) Press the ◀ or ▶ button to select **ALIGN PRINT HEAD**, then press the **OK** button. The print head alignment pattern is printed.

Note

If you select **HEAD ALIGN PRINT**, the machine exits the process after printing the current adjustment values.

- 4 Adjust the print head position.
 - (1) Check the printed patterns and press the ◀ or ▶ button to select the number of the pattern in column A that has the least noticeable streaks, then press the **OK** button.

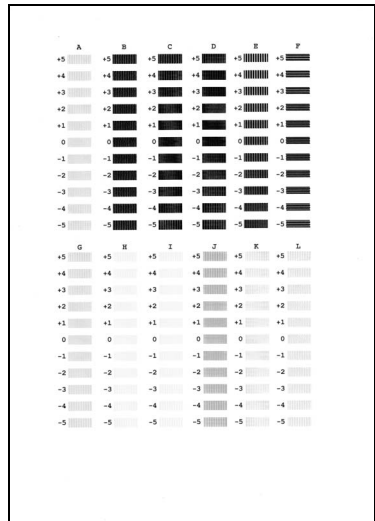

 **Note**

If it is difficult to pick the best pattern, pick the setting that produces the least noticeable white streaks.



(A)



(B)



(C)



(D)

- (A) Less noticeable vertical white streaks
 - (B) More noticeable vertical white streaks
 - (C) Less noticeable horizontal white streaks
 - (D) More noticeable horizontal white streaks
-

- (2) Repeat the procedure until you finish inputting the pattern number for column L.
- (3) Confirm the displayed message and press the **OK** button.
The second pattern is printed.
- (4) Check the printed patterns and press the ◀ or ▶ button to select the number of the pattern in column M that has the least noticeable streaks, then press the **OK** button.
In the same way in step (1), select the number.
- (5) Repeat the procedure until you finish inputting the pattern number for column R.

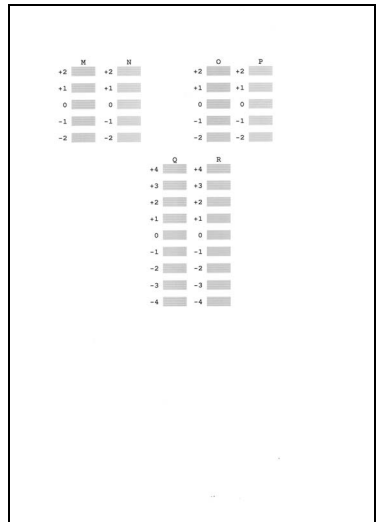

Replacing a FINE Cartridge

This section explains the way to confirm the ink status and the procedure to replace FINE Cartridges.

When ink runs out or other errors occur, an error message is displayed on the LCD to inform you of the error. See “An Error Message Is Displayed on the LCD” on page 76 and confirm how to handle it.

When printing from your computer, error messages appear on your computer screen as well.

Note

- If there is no improvement with the quality of printing following such maintenance as Print Head Cleaning, a FINE Cartridge is probably empty. When ink runs out, replace the FINE Cartridge. The machine cannot print if the wrong type of FINE Cartridge is used.
- For information on compatible FINE Cartridges, see the back cover of this guide.

Getting the Ink Status Information

You can confirm the status of FINE Cartridges in the following ways:

- “With the LCD of this Machine” on page 64
- “With the Computer Screen” on page 65

Note

The ink level detector is mounted on the machine to detect the remaining ink level. The machine considers as ink is full when a new FINE Cartridge is installed, and then starts to detect a remaining ink level. If you install a used FINE Cartridge, the indicated ink level of it may not be correct. In such case, refer to the ink level information only as a guide.

With the LCD of this Machine

You can check the current ink level by pressing the **COPY**, **SCAN**, or **FAX** button. The LCD will display the ink level for a few seconds.

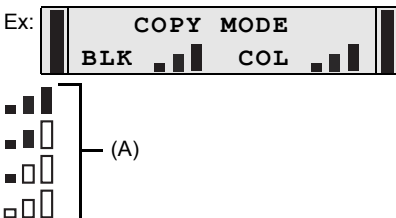

(A) Indicates the remaining ink volume at four different levels.

Take the appropriate action depending on the message displayed on the LCD as follows.

BLACK INK LOW
COLOR INK LOW

Ink is low. You can continue printing for a while, but we recommend you to have a new FINE Cartridge available.

CHECK INK
U163 BLK COL

Ink has run out. See “CHECK INK U163” in “An Error Message Is Displayed on the LCD” on page 76 and take appropriate action.

CHECK INK
U162 BLK COL

Ink may have run out. See “CHECK INK U162” in “An Error Message Is Displayed on the LCD” on page 76 and take appropriate action.

BLK INK VOL UNKNOWN
COL INK VOL UNKNOWN

RECOMMEND NEW B-CRT
RECOMMEND NEW C-CRT

The function for detecting the remaining ink level is disabled.

The statuses of a Color and Black FINE Cartridges may not be the same.

This message is displayed on the following occasions. We recommend that you replace the FINE Cartridge promptly.

- Ink is low while printing in fax mode
- Ink is low while receiving a fax in fax mode (the received fax is stored in memory.)

Note

If you select **ON** for **PRINT WHEN NO INK**, you can set this message not to be displayed. For details, refer to “AUTO PRINT RX” in “FAX SETTINGS” of the *User’s Guide* on-screen manual.

● With the Computer Screen

You can confirm the status of each FINE Cartridge on the printer status monitor (Windows) and Canon IJ Printer Utility (Macintosh).

Windows

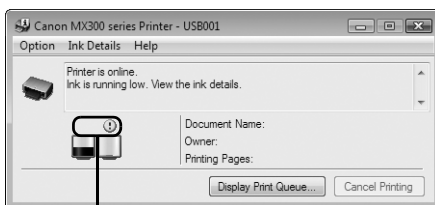

(A)

Macintosh

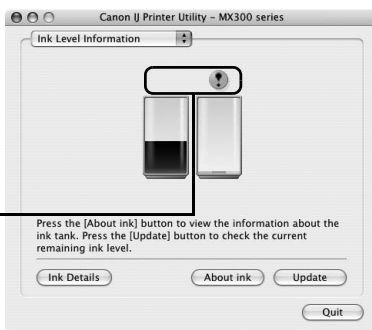

(A) Confirm whether any symbols are displayed here.



Ink is low. You can continue printing for a while, but we recommend you to have a new FINE Cartridge available.



Ink has run out. See “CHECK INK U163” in “An Error Message Is Displayed on the LCD” on page 76 and take appropriate action.



Ink may have run out. See “CHECK INK U162” in “An Error Message Is Displayed on the LCD” on page 76 and take appropriate action.



The function for detecting the remaining ink level is disabled.

Follow the procedure below to open each of the confirmation screens.

Windows

- 1 Open the printer properties dialog box.
Refer to “Opening the Printer Properties Dialog Box Directly from Control Panel” in “Opening the Printer Properties Dialog Box (Windows)” of the *User’s Guide* on-screen manual.
- 2 Click **View Printer Status** on the **Maintenance** sheet.
To confirm the FINE Cartridge information, click the **Ink Details** menu.

Note

You can also display the printer status monitor by clicking **Canon XXX Printer** (where “XXX” is your machine’s name) which appears on the taskbar during printing.

Macintosh

- 1 Open the Canon IJ Printer Utility.
Refer to “Opening the Canon IJ Printer Utility (Macintosh)” in the *User’s Guide* on-screen manual.
- 2 Select **Ink Level Information** in the pop-up menu.
To confirm the FINE Cartridge information, click **Ink Details**.

Note

If you have pressed the **Stop/Reset** button for at least 5 seconds when “**CHECK INK**”, “**BLK INK VOL UNKNOWN**”, or “**COL INK VOL UNKNOWN**” appears on the LCD, note the following.

- When ink runs out, printouts will become faint or blank printouts will be printed.
- When receiving faxes, the machine will not store it in its memory even if the ink level becomes low or run out.

■ Replacing FINE Cartridges

When FINE Cartridges run out of ink, replace them using the following steps.

● Important

Handling FINE Cartridges

- Do not touch the electrical contacts or Print Head Nozzles on a FINE Cartridge. The machine may not print out properly if you touch it.

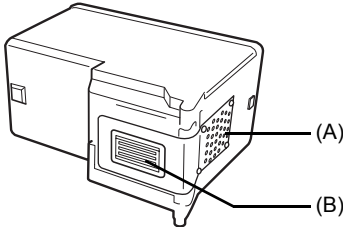

(A) Electrical Contacts

(B) Print Head Nozzles

- To maintain optimal printing quality, we recommend the use of specified Canon brand FINE Cartridges. Refilling ink is not recommended.
- Once you remove a FINE Cartridge, replace it immediately. Do not leave the machine with FINE Cartridges removed.
- Replace empty cartridges with new ones. If you insert FINE Cartridges that has been removed once, the machine may not print out properly due to some reasons such as clogging of the nozzles. Furthermore, with such cartridges, the Low Ink Warning may not be displayed properly.
- Once a FINE Cartridge has been installed, do not remove it from the machine and leave it out in the open. This will cause the FINE Cartridge to dry out, and the machine may not operate properly when it is reinstalled. To maintain optimal printing quality, use a FINE Cartridge within six months of first use.

📖 Note

- If a FINE Cartridge runs out of ink, you can print with either Color or Black FINE Cartridge, in whichever ink remains, only for a while. However the print quality may be reduced compared to when printing with both cartridges. Canon recommends to use new FINE cartridges in order to obtain optimum qualities. Even when printing with one ink only, print with leaving the empty FINE Cartridge installed. If either of the Color FINE Cartridge or Black FINE Cartridge is not installed, an error occurs and the machine cannot print. For information on how to configure this setting, refer to the *PC Printing Guide* on-screen manual.
- Color ink may be consumed even when printing a black-and-white document or when black-and-white printing is specified. Color ink is also consumed in Print Head Cleaning and Print Head Deep Cleaning, which may be necessary to maintain the machine's performance.

- 1 Make sure that the machine is turned on, lift the Scanning Unit (Printer Cover) with both hands, then pull the Scanning Unit Support (A) down into place.

The FINE Cartridge Holder moves to the left.

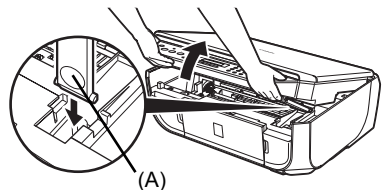

⚠ Caution

- Do not hold the FINE Cartridge Holder to stop or move it.
- Do not touch the metallic parts inside the machine.

🚫 Important

If the Scanning Unit (Printer Cover) is left open for more than 10 minutes, the FINE Cartridge Holder moves to the right. Close and reopen the Scanning Unit (Printer Cover) to return the holder to the left.

2 Remove the empty FINE Cartridge.

- (1) Push down the FINE Cartridge.

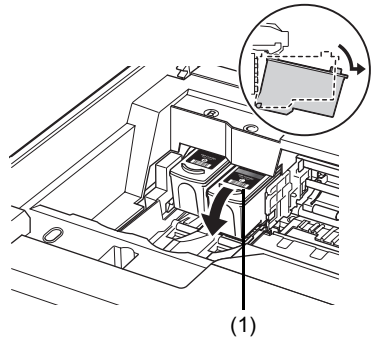

- (2) Remove the FINE Cartridge.

🚫 Important

- Handle FINE Cartridges carefully to avoid staining clothing or the surrounding area.
 - Discard empty FINE Cartridges according to the local laws and regulations regarding disposal of consumables.
-

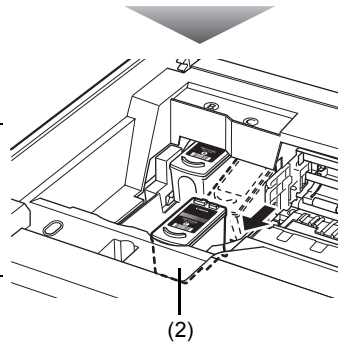

3 Prepare the replacement FINE cartridge.

- (1) Unpack a new FINE Cartridge and remove the orange protective tape (A) gently.

🚫 Important

- Handle FINE Cartridges carefully to avoid staining your clothes or surrounding work area.
 - Do not reattach the protective tape once you have removed it. Discard it according to the local laws and regulations regarding disposal of consumables.
 - Do not touch the electrical contacts or Print Head Nozzles on a FINE Cartridge. The machine may not print out properly if you touch it.
 - Be careful not to stain your clothes and hands with ink on the removed protective tape.
-

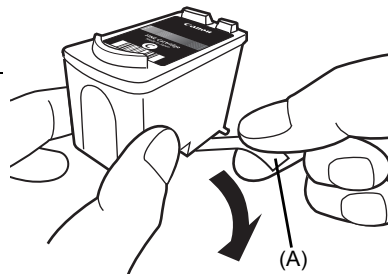

4 Install the FINE Cartridge.

- (1) Insert a new FINE Cartridge all the way into the appropriate slot.
The Black FINE Cartridge should be installed into the left slot (B) and the Color FINE Cartridge should be installed into the right slot (C).

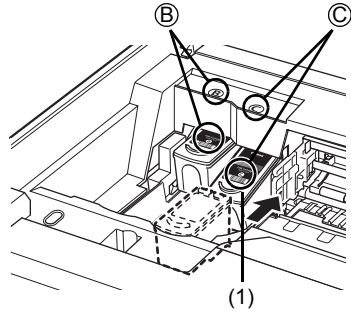

- (2) Push up the FINE Cartridge until it clicks into place.

Important

The machine cannot be used unless both the FINE Cartridges are installed.

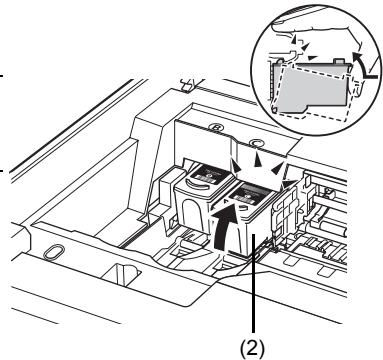

- ## 5 Lift the Scanning Unit (Printer Cover) slightly to set the Scanning Unit Support back to its original position, and then gently close the Scanning Unit (Printer Cover).

Caution

Be sure to hold the Scanning Unit (Printer Cover) firmly, and be careful not to get your fingers caught.

Note

- If the error message is still displayed after the Scanning Unit (Printer Cover) is closed, see “An Error Message Is Displayed on the LCD” on page 76.
 - When you start printing after replacing the FINE Cartridge, Print Head Cleaning is performed automatically. Do not perform any other operations until Print Head Cleaning finishes.
 - If the straight line is misaligned or the Print Head position is misaligned, align the Print Head position.
See “Aligning the Print Head” on page 62.
-

Keeping the Best Printing Results

To avoid drying of the Print Head and clogging of the nozzles, note the following.

Note

- Ink may blur depending on the paper in the following cases:
 - Printed area is traced with a highlight pen or paint-stick, or
 - Printed area is stained with water or sweat.
 - If the print head nozzles get clogged, printouts will become faint or particular colors will not be printed properly. For details, see “When Printing Becomes Faint or Colors Are Incorrect” on page 57.
-

■ When You Turn Off the Machine

Follow the procedure below to turn off the machine.

- (1) Press the **ON/OFF** button to turn off the machine.
- (2) Confirm that the **Power** lamp has gone out.
This takes a few seconds or as long as around 30 seconds.
- (3) Unplug the power cord from the wall outlet.
If you are using a power outlet strip, you can switch it off instead.

When you press the **ON/OFF** button to turn off the machine, the machine automatically puts a protective cap on the Print Head to prevent the ink from drying. If you remove the power cord or switch off the power outlet strip before the **Power** lamp goes out, this capping will not be done properly, causing the Print Head to dry and clog.

■ When You Are Not Using the Machine for a Long Time

When you are not using the machine for a long time, print or copy in both black & white and in color, or perform Print Head Cleaning, about once a month to prevent degradation of the Print Head.

Numerous nozzles are installed in the Print Head for high-precision printing. Just as the uncapped tip of a ballpoint pen or marker becomes dry and unusable if it is not used for a long period of time, the print head nozzles become blocked by dried ink. Periodically printing or cleaning the Print Head can prevent this blockage.

Cleaning Your Machine

This section describes the cleaning procedure that is needed to maintain your machine.

Caution

- Do not use tissue paper, paper towels, or similar materials for cleaning. Paper tissue powders or fine threads may remain inside the machine and cause problems such as a blocked Print Head and poor printing results. Use a soft cloth to avoid scratching the components.
 - Never use volatile liquids such as thinners, benzene, acetone, or any other chemical cleaner to clean the machine, as this may cause a malfunction or damage the machine's surface.
-

■ Cleaning the Exterior of the Machine

Caution

Be sure to turn off the power and disconnect the power cord before cleaning the machine.

Important

- When cleaning the exterior of the machine, do not use tissue paper, rough-textured cloth, or similar materials, as this may scratch the surface.
 - Never use neutral detergent or volatile liquids such as thinners, benzene, acetone, or any other chemical cleaner, as this may damage the surface.
-

Be sure to use a soft cloth such as eyeglasses cleaning cloth and wipe off dirt on the surface with it gently. Smooth out wrinkles on the cloth if necessary before cleaning.

■ Cleaning the Platen Glass and Document Cover

Caution

Be sure to turn off the power and disconnect the power cord before cleaning the machine.

Important

The inner side of the Document Cover (white sheet) (B) is easily damaged, so wipe it gently.

With a clean, soft, lint-free cloth, wipe the Platen Glass (A) and the inner side of the Document Cover (white sheet) (B) gently. Make sure not to leave any residue, especially on the Platen Glass.

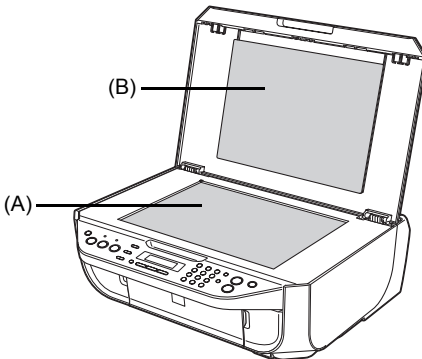

■ Cleaning the Paper Feed Roller (Roller Cleaning)

Clean the paper feed roller if paper is not fed properly. Cleaning the paper feed roller will wear the roller, so perform this only when necessary.

- 1 Make sure that the machine is turned on, and then remove any paper from the Rear Tray.
- 2 Open the Paper Output Tray.
 - (1) Put your finger in the rounded indent beside the Paper Output Tray and open it gently.
 - (2) Open up and set the Output Tray Extension completely by pressing down the hollow on its front side.
- 3 Clean the paper feed roller.
 - (1) Press the **Menu** button repeatedly until **MAINTENANCE** appears.
 - (2) Press the ◀ or ▶ button to select **ROLLER CLEANING**, then press the **OK** button. The paper feed roller will rotate as it is cleaned.
- 4 Repeat step 3 twice.
- 5 Make sure that the paper feed roller stops rotating, then load three or more sheets of A4 or Letter-sized plain paper in portrait orientation in the Rear Tray.

Set the Paper Thickness Lever to the left. For details on the Paper Thickness Lever, refer to "Inside" in "Main Components" of the *User's Guide* on-screen manual.
- 6 Repeat step 3 three times.

The paper cleans the paper feed roller as it feeds through the machine.

If the problem is not resolved, wipe the paper feed roller (A) located on the right side inside the Rear Tray with a moistened cotton swab or the like. Rotate the roller (A) manually as you clean it. Do not touch the roller with your fingers; rotate it with the cotton swab. If this does not solve the problem, contact your Canon service representative.

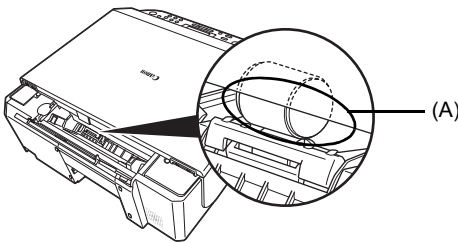

■ Cleaning the Inside of the Machine (Bottom Plate Cleaning)

This section describes how to clean the inside of the machine. If the inside of the machine becomes dirty, printed paper may get dirty, so we recommend performing cleaning regularly.

Important

Do not perform any other operation while the bottom plate is being cleaned.

- 1 Make sure that the machine is turned on, and then remove any paper from the Rear Tray.
- 2 Open the Paper Output Tray.
 - (1) Put your finger in the rounded indent beside the Paper Output Tray and open it gently.
 - (2) Open up and set the Output Tray Extension completely by pressing down the hollow on its front side.
- 3 Fold a single sheet of A4 or Letter-sized plain paper in half widthwise, and then unfold the paper.

- 4 Load this and only this sheet of paper in the Rear Tray with the open side to the front.

Set the Paper Thickness Lever to the left. For details on the Paper Thickness Lever, refer to "Inside" in "Main Components" of the *User's Guide* on-screen manual.

- 5 Perform bottom plate cleaning.
 - (1) Press the **Menu** button repeatedly until **MAINTENANCE** appears.
 - (2) Press the ◀ or ▶ button to select **BOTTOM CLEANING**, then press the **OK** button.
The paper cleans the inside of the machine as it feeds through the machine.

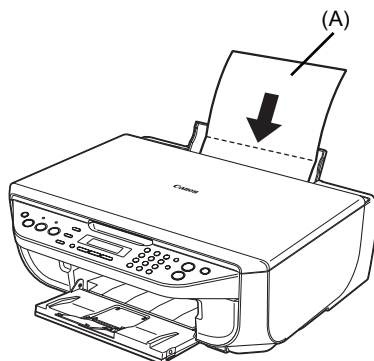

(A) Load the paper after unfolding it.

Check the folded part of the ejected paper. If it is smudged with ink, perform Bottom Plate Cleaning again.

If the problem is not resolved after performing Bottom Plate Cleaning twice, the protrusions inside the machine may be stained. Clean them according to instructions. See "Cleaning the Protrusions Inside the Machine" on page 74.

Note

When performing Bottom Plate Cleaning again, make sure to use a new piece of paper.

■ Cleaning the Protrusions Inside the Machine

If protrusions inside the machine are stained, wipe off any ink from the protrusions using a cotton swab or the like.

⚠ Caution

Be sure to turn off the power and disconnect the power cord before cleaning the machine.

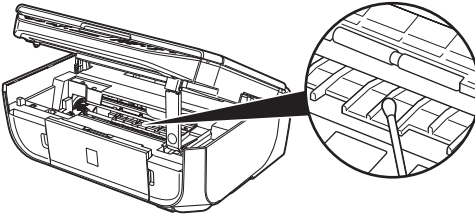

Troubleshooting

This section describes troubleshooting tips for problems you may encounter when using the machine.

Note

This section mainly describes the methods of machine operation for troubleshooting. To handle problems using your computer, refer to "Troubleshooting" in the *User's Guide* on-screen manual. For details on how to view the on-screen manuals, see "Reading the On-screen Manuals" on page 97.

- "An Error Message Is Displayed on the LCD" on page 76
- "LCD Cannot Be Seen At All" on page 78
- "An Unintended Language Is Displayed on the LCD" on page 79
- "Cannot Install the MP Drivers" on page 80
- "Cannot Connect to Computer Properly" on page 81
- "Print Results Not Satisfactory" on page 82
- "The Print Result Not Satisfactory When Copying" on page 86
- "Printing Does Not Start" on page 86
- "Paper Does Not Feed Properly" on page 87
- "Paper Jams" on page 88
- "Error Message Appears on the Computer Screen" on page 89
- "Error Message Appears on a PictBridge Compliant Device" on page 91
- "Scanning Problems" on page 92
- "Problems Receiving Faxes" on page 92
- "Problems Sending Faxes" on page 94
- "Telephone Problems" on page 95

Windows

If an Error Occurs When the Machine Is Connected to a Computer

When an error occurs in printing such as the machine is out of paper or paper is jammed, a troubleshooting message is displayed automatically. Take the appropriate action described in the message.

The message may vary depending on the version of your Windows operating system.

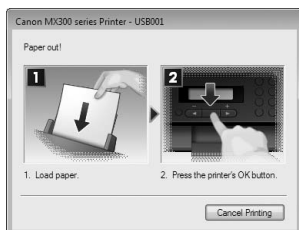

An Error Message Is Displayed on the LCD

If an error message is displayed on the LCD, take the corresponding action described below.

Message	Action
CHECK INK U051/U052/U053/U059	The FINE Cartridge may not be installed properly, or the Cartridge may not be compatible with this machine. Open the Scanning Unit (Printer Cover) and install the appropriate FINE Cartridge. If the error is not resolved, the FINE Cartridge may be damaged. Contact your Canon service representative.
CHECK INK U075/U076	Make sure that each FINE Cartridge is installed in the correct position. See "Replacing a FINE Cartridge" on page 64.
CHECK INK U140	The FINE Cartridge may not be compatible with this machine. Install the appropriate FINE Cartridge. See "Replacing a FINE Cartridge" on page 64.
CHECK INK U150	The FINE Cartridge may not be installed properly. Open the Scanning Unit (Printer Cover) and install the FINE Cartridge properly. If the error is not resolved, the FINE Cartridge may be damaged. Contact your Canon service representative.
CHECK INK U162	Ink may have run out. The function for detecting the remaining ink level will be disabled since the ink level cannot be correctly detected. If you want to continue printing without this function, press the Stop/Reset button for at least 5 seconds. Canon recommends to use new genuine Canon cartridges in order to obtain optimum qualities. Please be advised that Canon shall not be liable for any malfunction or trouble caused by continuation of printing under the ink out condition.
CHECK INK U163	Ink has run out. Replace the ink cartridge and close the Scanning Unit (Printer Cover). If printing is in progress and you want to continue printing, press the Stop/Reset button for at least 5 seconds with the ink cartridge installed. Then printing can continue under the ink out condition. The function for detecting the remaining ink level will be disabled. Replace the empty ink cartridge immediately after the printing. The resulting print quality is not satisfactory, if printing is continued under the ink out condition.
REQ. SERVICE SOON	The machine has a built-in ink absorber to hold the ink used during Print Head Cleaning, for example. This error message indicates that the ink absorber is nearly full. Press the OK button to cancel the error so you can continue printing. However, because printing is disabled once the ink absorber becomes completely full and until the ink absorber is replaced, you are recommended to contact your Canon service representative as early as possible. (You will need to replace a particular part of the machine.)
INCOMPATIBLE CAMERA	A communication time out occurs if an operation takes too long or if it takes too much time to send data. This may cancel printing. In such cases, disconnect and reconnect the USB cable. When printing from a PictBridge compliant device, depending on the model or brand of your device, you may have to select a PictBridge compliant print mode on the device before connecting it to the machine. You may also have to turn on your device or select Play mode manually after connecting the device to the machine. Perform necessary operations before connecting your device referring to its instruction manual. If the error is still not resolved, check if you can print another photograph.
UNSUPPORTED USB HUB	If a PictBridge compliant device is connected via a USB hub, remove the hub and connect it directly to the machine.

Message	Action
CHECK PRINTER	Turn off the machine, and unplug the power cord of the machine from the power supply. After a while, plug the power cord of the machine back in, and then turn on the machine. If the same error occurs, contact your Canon service representative.
SCANNER ERROR	Make sure that the protective material is removed from the FINE Cartridge Holder, then turn the machine off and back on again. If the problem is not resolved, contact your Canon service representative.
LOAD PAPER	Reload the paper correctly and press the OK button.  Note Pressing the Stop/Reset button also enables you to resolve the error, when sending faxes before printing out received data. After you press the Stop/Reset button to resolve the error, ensure to press the FAX button in order to print out data remained in memory.
PAPER JAMMED	If paper has jammed in the machine, clear the jam, reload the paper in the machine correctly and then press the OK button.
CHANGE PAPER TO	The paper size setting is set to a size other than A4, Letter or Legal. Set the paper size setting to A4, Letter or Legal and load paper of the same size.
COVER IS OPEN	You opened the Scanning Unit (Printer Cover) during an operation. Return the Scanning Unit (Printer Cover) to its original position.
DEVICE IN USE CANNOT TURN OFF	You are unable to turn off the machine with the ON/OFF button because the machine is performing an operation. The machine is performing an operation. Wait until the operation has finished, then turn off the machine.
MEMORY IS FULL	The machine's memory is full because it has received too many documents, or a very long or detailed document. Contact the sender and have him/her divide and resend them.

■ Fax Related Messages

Message	Action
BUSY/NO SIGNAL	<ul style="list-style-type: none"> ● The telephone number you dialed is busy. Try dialing again after waiting for a moment. See "Redialing" on page 43. ● The fax number dialed was incorrect. Check the fax number and dial again. ● The recipient's fax machine is not working. Contact the recipient and have them check their fax machine. ● The recipient is not using a G3 machine. Contact the recipient and ask them to send or receive the document using a G3 machine. ● The touch tone/rotary pulse setting on your machine is incorrect. Set the machine to the setting that matches your telephone line. See "Setting the Telephone Line Type" on page 30. ● The receiving fax machine did not answer within 55 seconds (after all automatic redialing attempts). Contact the recipient and have them check their fax machine. For an overseas call, add pauses to the registered number.
HANG UP PHONE	The handset is not placed in the handset cradle correctly. Replace the handset correctly.
NO ANSWER	The recipient's fax machine does not answer. Check the number. Try dialing again after waiting for a moment.
NO TONE DETECTED	The telephone line cable with a modular plug is not plugged in properly, or DIAL TONE DETECT is set to ON . Make sure that the cable is plugged in properly, and resend the fax after a while. If you still cannot send the fax, set DIAL TONE DETECT to OFF .

Message	Action
NO RX PAPER	The other party's fax machine is out of paper or its memory is full. Contact the other party and have them load paper in their fax machine or free up space in their fax machine's memory.
NO TEL NUMBER	The coded speed dialing code you entered has not been registered. Register the coded speed dialing code.
RECEIVED IN MEMORY	If the machine receives a fax under one of the following conditions, the machine will not be able to print the received fax and will store it in its memory. When the problem is resolved as described, the fax stored in memory is printed automatically. <ul style="list-style-type: none"> ● Ink is low or has run out while receiving a fax: replace the FINE Cartridge. See "Replacing a FINE Cartridge" on page 64. ● Paper size/type setting is incorrect: correct the paper size/type setting. ● Paper has run out while receiving a fax: load the paper and press the OK button. ● Output Tray is closed: open it. ● OFF is selected for AUTO PRINT RX: select ON. ● You pressed the Stop/Reset button to cancel printing of a fax: press the FAX button.
TRY AGAIN IN B&W	The recipient's fax machine is not color-compatible. Press the Black button to resend the faxes.
TX/RX CANCELLED	You pressed the Stop/Reset button to cancel the transmission. If required, try sending or receiving again.
TX/RX NO.nnnn	When the machine sends or receives a fax, it assigns a unique identification number (nnnn). Write the number down if you will need it later.



LCD Cannot Be Seen At All



Cause	Action
The machine is not powered on or the LCD is in the screen-saver mode.	<ul style="list-style-type: none"> ● If the Power lamp is off The machine is not powered on. Connect the power cord and press the ON/OFF button. The machine will power on and the LCD will display a message. ● If the Power lamp is lit The LCD may be in the screen-saver mode. On the Operation Panel, press a button other than the ON/OFF button.

An Unintended Language Is Displayed on the LCD

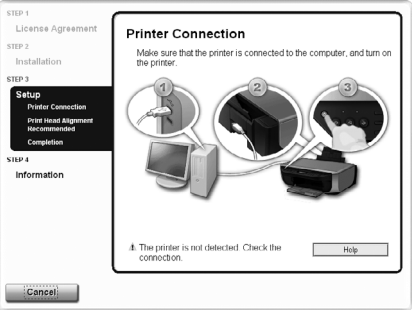
Cause	Action
The language you want to be displayed is not selected.	<p>Select the language according to the following procedure.</p> <ol style="list-style-type: none">(1) Press the ON/OFF button to turn on the machine.(2) Press the Menu button three times.(3) Press the ▶ button twice, then press the OK button.(4) Press the ▶ button once, then press the OK button.(5) Press the ◀ button repeatedly to select the leftmost language.(6) Press the ▶ button the number of times in the following list according to your desired language.<ul style="list-style-type: none">– JAPANESE: 0 time– ENGLISH: 1 time– GERMAN: 2 times– FRENCH: 3 times– ITALIAN: 4 times– SPANISH: 5 times– DUTCH: 6 times– PORTUGUESE: 7 times– NORWEGIAN: 8 times– SWEDISH: 9 times– DANISH: 10 times– FINNISH: 11 times– RUSSIAN: 12 times– CZECH: 13 times– HUNGARIAN: 14 times– POLISH: 15 times– SLOVENE: 16 times– TURKISH: 17 times(7) Press the OK button.<p>The desired language is displayed on the LCD.</p>(8) Press the Stop/Reset button.

Cannot Install the MP Drivers

Cause	Action
<p>Windows</p> <p>Unable to proceed beyond the Printer Connection screen.</p>	<p>If you were unable to proceed beyond the Printer Connection screen, follow the procedure below to reinstall the MP Drivers.</p>  <ol style="list-style-type: none"> (1) Click Cancel on the Printer Connection screen. (2) Click Start Over on the Installation Failure screen. (3) Click Back on the screen that appears next. (4) Click Exit on the PIXMA XXX screen (where “XXX” is your machine’s name), then remove the CD-ROM. (5) Turn the machine off. (6) Restart your computer. (7) Make sure you have no application software running, including anti-virus software. (8) Follow the procedure described in your setup sheet to reinstall the MP Drivers.
<p>Installation does not start automatically when the <i>Setup CD-ROM</i> is inserted into your computer’s disc drive.</p>	<p>Windows</p> <ol style="list-style-type: none"> (1) Click Start then Computer. In Windows XP, Click Start then My Computer. In Windows 2000, double-click the My Computer icon on the desktop. (2) Double-click the CD-ROM icon  on the displayed window. <p>Note</p> <p>To use the Run command to start the setup program, specify your disc drive and then the name of the setup program, MSETUP4.EXE. The drive letter of the disc drive depends on your computer.</p> <p>Macintosh</p> <p>Double-click the CD-ROM icon on your desktop to start installation.</p> <p>If the CD-ROM icon is not displayed, restart your computer.</p> <p>If the CD-ROM icon is still not displayed, try different disks and see if they are displayed. If other disks are displayed, there is a problem with the <i>Setup CD-ROM</i>. Contact your Canon service representative.</p>

Cause	Action
<p>Installation procedure not followed correctly.</p>	<p>Follow the procedure described in your setup sheet for proper installation.</p> <p>If the MP Drivers were not installed correctly, uninstall the MP Drivers, restart your computer, and then reinstall the MP Drivers. Refer to the <i>PC Printing Guide</i> on-screen manual.</p> <p></p> <p> Note</p> <p>If the installer was forced to be terminated due to a Windows error, the system may be in an unstable condition and you may not be able to install the MP Drivers. Restart your computer before reinstalling.</p>

Cannot Connect to Computer Properly

■ Printing Speed Is Slow / USB 2.0 Hi-Speed Connection Does Not Work

Cause	Action
<p>Your system environment is not fully compatible with USB 2.0 Hi-Speed.</p>	<p>If your system environment is not fully compatible with USB 2.0 Hi-Speed, the machine will operate at a lower speed provided under USB 1.1. In this case, the machine operates properly but printing speed may slow down due to communication speed.</p> <p>Check the following to ensure that your system environment supports USB 2.0 Hi-Speed connection.</p> <ul style="list-style-type: none"> ● The USB port on your computer supports USB 2.0 Hi-Speed connection. ● The USB cable, and the USB hub if you are using one, support USB 2.0 Hi-Speed connection. <p>Be sure to use a certified USB 2.0 Hi-Speed cable. We recommend the cable to be no longer than around 10 feet / 3 meters.</p> <ul style="list-style-type: none"> ● The operating system of your computer supports USB 2.0 Hi-Speed connection. <p>Obtain and install the latest update for your computer.</p> <ul style="list-style-type: none"> ● The USB 2.0 Hi-Speed driver operates properly. <p>Obtain the latest version of the USB 2.0 Hi-Speed driver compatible with your hardware and install it on your computer.</p> <p> Important</p> <p>For details on USB 2.0 Hi-Speed of your system environment, contact the manufacturer of your computer, USB cable, or USB hub.</p>



■ “This device can perform faster” Message Is Displayed

Cause	Action
<p>Your system environment is not fully compatible with USB 2.0 Hi-Speed.</p>	<p>Your system environment is not compatible with USB 2.0.</p> <p>See “Printing Speed Is Slow / USB 2.0 Hi-Speed Connection Does Not Work” on page 81.</p>

Print Results Not Satisfactory

If the print result is not satisfactory, confirm the paper and print quality settings first.

● Do the page size and media type settings match the size and type of the loaded paper?

When these settings are incorrect, you cannot obtain a proper print result. If you are printing a photograph or an illustration, incorrect paper type setting may reduce the quality of printout color. Also, if you print with an incorrect paper type setting, the printed surface may be scratched. In borderless printing, uneven coloring may occur depending on the combination of the paper type setting and the loaded paper.

● Did you set the print quality setting appropriately?

Select a print quality option suitable to the paper and image for printing. If you notice blurs or uneven colors, increase the print quality setting and try printing again.

* When printing from a PictBridge compliant device, set the print quality setting by using the Operation Panel on the machine. You cannot make this setting from a PictBridge compliant device.

The method to confirm the paper and print quality settings differs depending on what you do with your machine.

To copy by operating the machine	Confirm by using the Operation Panel on the machine. Refer to the <i>User's Guide</i> on-screen manual.
To print from a PictBridge compliant device	Confirm by using your PictBridge compliant device or the Operation Panel on the machine. See "Printing Photographs Directly from a Compliant Device" on page 23.
To print from a computer	Confirm by using the printer driver. Refer to the <i>PC Printing Guide</i> on-screen manual.

If the problem is not resolved even if the paper and print quality settings are correct, there may be other causes. See also the sections below.

■ Colors Are Unclear

Cause	Action
Color correction is not enabled.	When printing photographs or other graphics, enabling color correction may improve color. When performing direct printing, select VIVID ON in the print settings. When printing from your computer, refer to "Print Results Not Satisfactory" in the <i>User's Guide</i> on-screen manual.

■ Printing Does Not Start/Printing Is Blurred/Colors Are Wrong/Straight Lines Are Misaligned

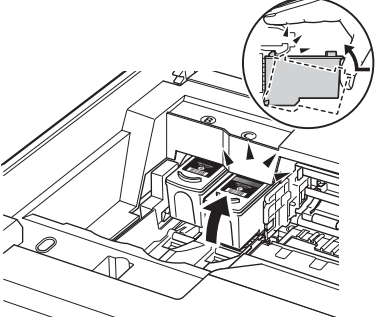
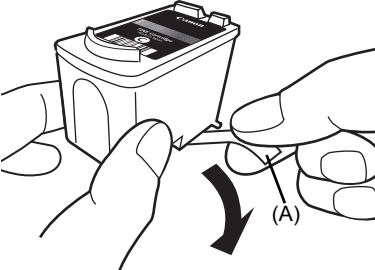
Cause	Action
<p>FINE Cartridge is not installed properly. / There is no ink left.</p>	<p>Remove the FINE Cartridge, then reinstall it. Small dusts may be stuck between the contact points. In this case, the print result may be improved by reinstalling the FINE Cartridge.</p>  <p>Also, check that the protective tape (A) is removed.</p> 
<p>Print Head nozzles are clogged.</p>	<p>See "When Printing Becomes Faint or Colors Are Incorrect" on page 57 and perform any necessary maintenance operation.</p>
<p>The media is loaded with the wrong side facing upwards.</p>	<p>Many types of paper are made to be printed on only a particular side of the paper. Printing on the wrong side may cause unclear prints or prints with reduced quality. For detailed information on the printable side, refer to the instruction manuals supplied with the paper.</p>
<p>Print Head is misaligned.</p>	<p>If you did not align the Print Head after installation, straight lines may be printed misaligned. Make sure to align the Print Head after you install it. See "Aligning the Print Head" on page 62 to perform Print Head Alignment using the Operation Panel.</p>

■ White Streaks

Cause	Action
<p>Print Head nozzles are clogged.</p>	<p>See "When Printing Becomes Faint or Colors Are Incorrect" on page 57 and perform any necessary maintenance operation.</p>

■ Printed Paper Curls or Has Ink Blots

Cause	Action
Paper is too thin.	When printing data with high color saturation such as photographs or images in deep color, we recommend using Photo Paper Pro or other Canon specialty paper. See "Media Types You Cannot Use" on page 11.

■ Printed Surface Is Scratched/Paper Is Smudged

Cause	Action
Paper feed roller is dirty.	Clean the paper feed roller. Cleaning the paper feed roller will wear the roller, so perform this procedure only when necessary. For details on cleaning, see "Cleaning the Paper Feed Roller (Roller Cleaning)" on page 72.
Inside of the machine is dirty.	When performing duplex printing, if the specified page size does not match the actual size of paper loaded in the paper source, the inside will become stained with ink, causing printed paper to become smudged. Perform the Bottom Plate Cleaning to clean the inside of the machine. For details on cleaning, see "Cleaning the Inside of the Machine (Bottom Plate Cleaning)" on page 73. Note To prevent the inside of the machine from getting stained, set the page size correctly.
Printing on inappropriate type of paper.	<ul style="list-style-type: none"> ● Check to see if the paper you are printing on is not too thick or curled. See "Media Types You Cannot Use" on page 11. ● When performing Borderless Printing, print quality may be reduced at the top and bottom edges of the paper. Make sure that the paper you are using is suitable for Borderless Printing. For details, refer to "Printing Area" in the <i>User's Guide</i> on-screen manual.

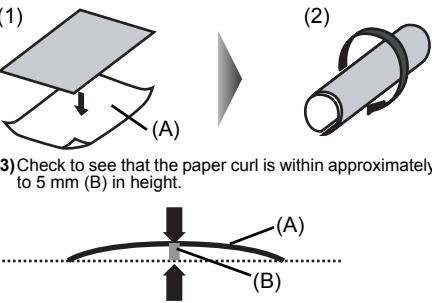
Cause	Action
Paper is curled.	<p>For Plain Paper</p> <p>Turn the paper over and reload it to print on the other side.</p> <p>Leaving the paper loaded in the Rear Tray for a long time may cause the paper to curl. If this happens, load the paper with the other side facing up. It may resolve the problem.</p> <p>We recommend putting unused paper back into the package and keep them on a level surface.</p> <p>For Other Paper</p> <p>If you are using paper with either any of the corners or the whole printing surface curled, the paper may become dirty, not feed properly, or both. Use such paper after correcting paper curl as follows.</p> <p>(1) With the printing side (A) facing up, cover the paper with a fresh sheet of plain paper to avoid staining or scratching the surface.</p> <p>(2) Roll up the paper in a direction opposite to paper curl as seen below.</p>  <p>(3) Check to see that the paper curl is within approximately 0.08 to 0.2 inches / 2 to 5 mm (B) in height.</p> <p>We recommend printing curl-corrected paper one sheet at a time.</p> <p>Note</p> <p>Depending on the media type, the paper may be smudged or may not be fed properly even if it is not curled.</p> <p>In such case, follow the procedure described above in "For Other Paper" to curl the paper before printing.</p> <p>This may improve the print result.</p>
Inappropriate Paper Thickness Lever setting.	<p>Adjust the position of the Paper Thickness Lever according to the type of paper you are printing on.</p> <p>See "Paper Handling" on page 10.</p> <p>Depending on the printing content, the printing surface may become scratched even for the types of paper to set the lever to the left. In this case, set the Paper Thickness Lever to the right.</p> <p>* Reset the Paper Thickness Lever to the left when you finish printing. If the lever is not set back to the left, the inside of the machine is more likely to get dirty due to the wider clearance between the print head and the loaded paper. It may also reduce print quality.</p> <p>Note</p> <p>If the corners or edges of the paper are smudged, try to print with the Paper Thickness Lever set to the right.</p>
Printing graphics with the intensity setting set too high.	<p>Especially if you are using plain paper to print images with high intensity, the paper may absorb too much ink and become wavy, causing paper abrasion.</p> <p>When copying, see "Changing the Copy Settings" on page 17 and reduce the INTENSITY setting. Then try printing again.</p> <p>When printing from your computer, refer to "Print Results Not Satisfactory" in the <i>User's Guide</i> on-screen manual.</p>
Printing beyond the recommended printing area.	<p>If you are printing beyond the recommended printing area of your printing paper, the lower edge of the paper may become stained with ink.</p> <p>Resize your original document in your application software.</p> <p>For details on recommended printing area, refer to "Printing Area" in the <i>User's Guide</i> on-screen manual.</p>

■ Colors Are Uneven or Streaked

Cause	Action
Print Head nozzles are clogged.	See "When Printing Becomes Faint or Colors Are Incorrect" on page 57 and perform any necessary maintenance operations.
Print Head is misaligned.	See "Aligning the Print Head" on page 62 to perform Print Head Alignment using the Operation Panel.

The Print Result Not Satisfactory When Copying

Cause	Action
The original document is not loaded correctly.	Check that the original is loaded correctly on the Platen Glass. See "Loading Original Documents" on page 8.
The original document is not loaded with the side to be copied face down.	When loading the original on the Platen Glass, the side to be copied should be face down.
The original document is a printout from this machine.	Print quality may be reduced if you copy a printout. Instead of copying a printout, print the original directly either from the digital camera or your computer.
The Platen Glass or the inner side of the Document Cover is dirty.	Clean the Platen Glass and the inner side of the Document Cover. See "Cleaning the Platen Glass and Document Cover" on page 71.

If these do not resolve the problem, also see "Print Results Not Satisfactory" on page 82.

Printing Does Not Start

Cause	Action
Unnecessary print jobs are left in queue. / Computer problems.	<p>Restarting your computer may solve the problem. If there are any unnecessary print jobs, follow the procedure below to delete them.</p> <p>Windows</p> <ol style="list-style-type: none"> Open the printer properties dialog box. Refer to "Opening the Printer Properties Dialog Box Directly from Control Panel" in "Opening the Printer Properties Dialog Box (Windows)" of the <i>User's Guide</i> on-screen manual. Click the Maintenance tab and then View Printer Status. The printer status monitor is displayed. Click Display Print Queue. Select Cancel All Documents on the Printer menu. You may not be able to select this depending on the privileges of the account. When the confirmation message is displayed, click Yes. The print jobs are deleted. <p>Macintosh</p> <ol style="list-style-type: none"> Click the printer icon in the Dock to display the list of print jobs in progress. In Mac OS X v.10.2.8, click the printer icon in the Dock to start up the Print Center and double-click the name of your machine in the Printer List. Select the print job to delete and click . The print jobs are deleted.

Cause	Action
The machine is not ready.	<p>Check if the Power lamp is lit green. If the Power lamp is off, turn the machine on. While the Power lamp is flashing green, the machine is initializing. Wait until the Power lamp stops flashing and remains lit green.</p> <p> Note When printing large data such as a photo or graphics, it may take longer to start printing.</p>

Paper Does Not Feed Properly

Cause	Action
Printing on inappropriate type of paper.	Check to see if the paper you are printing on is not too thick or curled. See "Media Types You Cannot Use" on page 11.
Paper feed roller is dirty.	Clean the paper feed roller. Cleaning the paper feed roller will wear the roller, so perform this procedure only when necessary. For details on cleaning, see "Cleaning the Paper Feed Roller (Roller Cleaning)" on page 72.
Paper not loaded properly.	<p>Make sure of the following when you load paper in the machine.</p> <ul style="list-style-type: none"> ● When loading two or more sheets of paper, align the edges of the sheets before loading. ● Always load the paper in portrait orientation in the Rear Tray, regardless of the printing orientation. ● Load the paper with the print side facing UP. Align the paper stack against the right side of the Rear Tray and slide the Paper Guide so that it just touches the left edge of the stack. <p>For details on loading paper, see "Loading Paper" on page 12.</p>
Too much paper loaded.	<p>Make sure that the paper stack does not exceed the load limit. However, proper feeding of paper may not be possible at this maximum capacity depending on the type of paper or environmental conditions (either very high or low temperature and humidity).</p> <p>In such cases, reduce the sheets of paper you load at a time to around half. For details on loading paper, see "Loading Paper" on page 12.</p>
Foreign object in the Rear Tray.	Make sure that there are no foreign objects in the Rear Tray.
Envelopes not prepared nor loaded properly.	<ul style="list-style-type: none"> ● When printing on envelopes, see "Loading Envelopes" on page 14, and prepare the envelopes before printing. Once you have prepared the envelopes, load them in the machine in portrait orientation. If the envelopes are placed in landscape orientation, they will not feed properly. ● Set the Paper Thickness Lever to the right.

Paper Jams

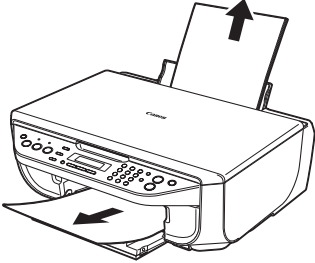
Cause	Action
<p>Paper jammed in the Paper Output Slot or the Rear Tray.</p>	<p>Remove the paper following the procedure below.</p> <p>(1) Slowly pull the paper out, either from the Rear Tray or from the Paper Output Slot, whichever is easier.</p>  <ul style="list-style-type: none"> ● If the paper tears and a piece remains inside the machine, turn the machine off, open the Scanning Unit (Printer Cover) and remove it. Be careful not to touch the components inside the machine. After removing all paper, close the Scanning Unit (Printer Cover), and turn it back on. ● If you cannot pull the paper out, turn the machine off and turn it back on. The paper will be ejected automatically. <p>(2) Reload the paper in the machine, and press the OK button on the machine. If you turned off the machine in step (1), all print jobs in queue are canceled. Reprint if necessary.</p> <p>Note</p> <ul style="list-style-type: none"> ● For details on how to load paper, see "Loading Printing Paper" on page 9. ● When reloading the paper in the machine, see "Paper Does Not Feed Properly" on page 87 to confirm that you are using the correct paper and are loading it into the machine correctly. <p>If you cannot remove the paper or the paper tears inside the machine, or if the paper jam error continues after removing the paper, contact your Canon service representative.</p>
<p>Landscape credit card-sized paper jammed inside the machine.</p>	<p>Do not load credit card-sized paper in landscape orientation. Slowly pull out the paper from the Rear Tray and remove it. If you cannot remove the jammed paper or the paper jam error continues after removing the paper, contact your Canon service representative.</p>

Error Message Appears on the Computer Screen



■ Writing Error/Output Error/Communication Error

Cause	Action
The machine is not ready.	<p>Confirm that the Power lamp is lit green.</p> <p>If the Power lamp is off, turn the machine on.</p> <p>While the Power lamp is flashing green, the machine is initializing. Wait until the Power lamp stops flashing and remains lit green.</p> <p>If the Alarm lamp is lit orange, an error may have occurred on the machine. For details on how to resolve the error, see "An Error Message Is Displayed on the LCD" on page 76.</p>
Printer port setting does not match the computer's interface connecting the machine.	<p>Check the printer port settings.</p> <p>* In the following instruction, "XXX" signifies your machine's name.</p> <p>(1) Log into a user account with the administrator privilege.</p> <p>(2) Click Control Panel, then Printer under Hardware and Sound. In Windows XP, click Control Panel, Printers and Other Hardware, then Printers and Faxes. In Windows 2000, click Control Panel then Printers.</p> <p>(3) Right-click the Canon XXX Printer icon, and select Properties.</p> <p>(4) Click the Ports tab to confirm the port settings. Make sure that a port named USBnnn (where "n" is a number) with Canon XXX Printer appearing in the Printer column is selected for Print to the following port(s). If the port setting is not correct, reinstall the MP Drivers or change the port setting according to the interface you are using.</p>
The machine is not connected properly.	<p>Make sure that the USB cable is securely plugged in to the machine and the computer.</p> <ul style="list-style-type: none"> ● If you are using a relay device such as a USB hub, disconnect it, connect the machine directly to the computer, and try printing again. If printing starts normally, there is a problem with the relay device. Consult the reseller of the relay device for details. ● There could also be a problem with the USB cable. Replace the USB cable and try printing again.
MP Drivers are not installed properly.	<p>The MP Drivers may not be installed properly. Uninstall them following the procedure described in the <i>PC Printing Guide</i> on-screen manual and reinstall them following the procedure described in your setup sheet.</p>

■ Error No.: 300 Is Displayed

Cause	Action
The machine is not ready.	Confirm that the Power lamp is lit green. If the Power lamp is off, turn the machine on. While the Power lamp is flashing green, the machine is initializing. Wait until the Power lamp stops flashing and remains lit green. If the Alarm lamp is lit orange, an error may have occurred on the machine. For details on how to resolve the error, see "An Error Message Is Displayed on the LCD" on page 76.
Machine is not connected properly.	Make sure that the USB cable is securely plugged in to the machine and the computer. <ul style="list-style-type: none"> ● If you are using a relay device such as a USB hub, disconnect it, connect the machine directly to the computer, and try printing again. If printing starts normally, there is a problem with the relay device. Consult the reseller of the relay device for details. ● There could also be a problem with the USB cable. Replace the USB cable and try printing again.
Your machine is not selected in Printer on the Print dialog box.	Select your machine's name in Printer on the Print dialog box. If your machine's name does not appear in Printer , follow the procedure below to check that the driver for your machine is installed to your computer. <ol style="list-style-type: none"> (1) Select Print & Fax Preferences in Printer. In Mac OS X v.10.2.8 or 10.3.x, select Edit Printer List in Printer. (2) Check that your machine's name is displayed in the list of printers and that the check box is selected. In Mac OS X v.10.2.8, check that your machine's name is displayed in Printer List. (3) If your machine's name is not displayed, click Add(+) to add the machine. If you cannot add the machine, follow the procedure described in your setup sheet to reinstall the MP Drivers.

■ Error No.: 1700/1710 Is Displayed

Cause	Action
The ink absorber is almost full.	See "REQ. SERVICE SOON" in "An Error Message Is Displayed on the LCD" on page 76.

■ Error No.: 2001 Is Displayed

Cause	Action
No response from connected digital camera or video camcorder. / Connected digital camera or video camcorder is not compatible with this machine.	See "INCOMPATIBLE CAMERA" in "An Error Message Is Displayed on the LCD" on page 76.

■ Error No.: 2002 Is Displayed

Cause	Action
PictBridge compliant device is connected via a USB hub.	See "UNSUPPORTED USB HUB" in "An Error Message Is Displayed on the LCD" on page 76.

Error Message Appears on a PictBridge Compliant Device

The following are the possible errors that may occur when printing directly from a PictBridge compliant device and the countermeasures to clear them.

 **Note**

- This section describes errors that are indicated on Canon-brand PictBridge compliant devices. The error messages and operations may vary depending on the device you are using. For errors on non-Canon PictBridge compliant devices, check the error message on the LCD and take the appropriate action to clear the error. For details, see "An Error Message Is Displayed on the LCD" on page 76.
- For the errors indicated on the PictBridge compliant device and their solution, also refer to the instruction manual of the device. For other troubles on the device, contact the manufacturer.

Error Message On PictBridge Compliant Device	Action
"Printer in use"	If the machine is printing from the computer or warming up, wait until the job ends. When it is ready, the machine starts printing automatically. When printing first after changing the media type, the message asking you to confirm the position of the paper thickness lever may appear on the LCD on the machine. If this message is displayed, make sure that the paper thickness lever is set appropriate, then press the OK button on the machine.
"No paper"	Load paper in the Rear Tray, and select Continue* in the display on your PictBridge compliant device. * To resume printing, you can also press the OK button on the machine instead of selecting Continue on the camera.
"Paper Error"	Open the Paper Output Tray. The machine resumes printing.
"Paper jam"	Select Stop in the display on your PictBridge compliant device to stop printing. Remove the jammed paper, load new paper, press the OK button on the machine, and try printing again.
"Printer cover open"	Close the Scanning Unit (Printer Cover) on the machine.
"No print head"	The FINE Cartridge is not installed or the Cartridge may not be compatible with this machine. For details on how to resolve the error, see "CHECK INK U051/U052/U053/ U059" in "An Error Message Is Displayed on the LCD" on page 76.
"Waste tank full"/ "Ink absorber full"	The ink absorber is nearly full. For details on how to resolve the error, see "REQ. SERVICE SOON" in "An Error Message Is Displayed on the LCD" on page 76.

Error Message On PictBridge Compliant Device	Action
"No ink"/ "Ink cassette error"	<ul style="list-style-type: none"> ● The FINE Cartridge has or may have run out of ink. ● The FINE Cartridge may not be installed properly or may not be compatible with this machine. Check the error message on the LCD and take the appropriate action to resolve the error. See "An Error Message Is Displayed on the LCD" on page 76.
"Hardware Error"	FINE Cartridge errors have occurred. Replace the FINE Cartridge. See "Replacing a FINE Cartridge" on page 64.
"Printer error"	An error requiring servicing may have occurred. (Machine Power lamp flashes green and Alarm lamp flashes orange alternately.) Disconnect the USB cable between the machine and the PictBridge compliant device, turn off the machine, and unplug the power cord of the machine from the power supply. After a while, plug the power cord of the machine back in, turn on the machine, and then reconnect the PictBridge compliant device to the machine. If the same error occurs, contact your Canon service representative.

Scanning Problems

■ ScanGear Won't Start

Cause	Action
The scanner driver (ScanGear) is not installed.	Follow the procedure described in your setup sheet to reinstall the MP Drivers.

■ Other Scanning Troubles

Refer to the *Scanning Guide* on-screen manual.

Problems Receiving Faxes

■ Cannot Receive a Fax, Cannot Print a Fax

Cause	Action
The machine is not powered on.	<ul style="list-style-type: none"> ● You cannot receive faxes if the power is turned off. Press the ON/OFF button to turn the power on. ● After a power failure or disconnecting of the power cord, press the ON/OFF button to turn the power on.
The machine's memory is full.	Either print or delete documents in memory (see "Printing or Deleting a Document in Memory" on page 52.) to free up memory. Then ask the sender to resend the fax.
There was an error during reception.	<ul style="list-style-type: none"> ● Check the LCD for an error message. See "An Error Message Is Displayed on the LCD" on page 76. ● Print the Activity report and check for an error. See "Printing the Activity Report Manually" on page 55.
The telephone line is not correctly connected.	Check that the telephone line is connected correctly to the Telephone Line Jack and that the telephone (or another external device such as an answering machine or a computer modem) is connected correctly to the External Device Jack. Refer to your setup sheet.

Cause	Action
A paper size other than A4, Letter or Legal* is loaded.	If a paper size other than A4, Letter or Legal* is loaded, incoming faxes are not printed and are stored in memory. Change the paper to A4, Letter or Legal* size, then press the OK button on the machine.
The machine is not set to the appropriate receive mode.	<p>Check the receive mode setting, and change it to a mode suited to your connection if necessary.</p> <p>FAX ONLY MODE</p> <p>See "If You Want to Receive Only Faxes Automatically with the Machine, or Have a Dedicated Telephone Line for Fax Use Only:" on page 46.</p> <p>TEL PRIORITY MODE</p> <p>See "If You Are Using a Single Telephone Line for Faxes and Voice Calls and Use Voice Calls More Frequently:" on page 46.</p> <p>FAX PRIORITY MODE</p> <p>See "If You Are Using a Single Telephone Line for Faxes and Voice Calls and Want to Receive Faxes Automatically:" on page 47.</p> <p>DRPD</p> <p>See "If You Subscribe to a Distinctive Ring Pattern Detection (DRPD) Service with Your Telephone Company (US and Canada only):" on page 48.</p> <p>NETWORK SWITCH</p> <p>See "If You Want the Machine to Automatically Switch between Fax and Voice Calls by the Call Ring Patterns (Network Switch):" on page 48.</p>

* Legal may not be available depending on the country or region of purchase.

■ Machine Does Not Switch Automatically between Voice and Fax Calls

Cause	Action
The receive mode displayed on the bottom left of the LCD is FAXONLY .	<p>If the receive mode is set to FAX ONLY MODE, there will be no automatic switching between voice and fax calls. Set the receive mode to TEL PRIORITY MODE, FAX PRIORITY MODE, DRPD¹, or NETWORK SWITCH².</p> <p>If the receive mode is TEL PRIORITY MODE, connect an answering machine to the machine and check that a message plays back when the answering machine answers.</p>

¹ This setting is only available in US and Canada.

² This setting may not be available depending on the country or region of purchase.

■ Quality of Received Fax is Poor

Cause	Action
ECM RX is set to OFF .	Set ECM RX to ON . Refer to "ECM RX" in "FAX SETTINGS" of the <i>User's Guide</i> on-screen manual.
The sender's original document or fax machine is dirty.	The image quality of the fax is mainly determined by the sender's fax machine. Contact the sender and check whether the scanning area of his/her fax machine is not dirty.
ECM sending/receiving is not enabled although the line/connection is poor.	<ul style="list-style-type: none"> ● On the machine, set ECM RX to ON. Refer to "ECM RX" in "FAX SETTINGS" of the <i>User's Guide</i> on-screen manual. ● Contact the sender and check that his/her machine is set to enable ECM sending. ● If the sender's or receiver's fax is not ECM-compatible, the fax will be sent/received in the standard mode. ● Reduce the reception start speed. Refer to "RX START SPEED" in "FAX SETTINGS" of the <i>User's Guide</i> on-screen manual.

■ Repeated Errors Occur When You Receive a Fax

Cause	Action
The telephone line condition or the connection is poor.	Reduce the reception start speed. Refer to "RX START SPEED" in "FAX SETTINGS" of the <i>User's Guide</i> on-screen manual. If there is a poor line or connection, reducing the reception start speed may correct the error.
The sender's fax machine is not operating normally.	Contact the sender and check whether his/her fax machine is operating normally.

Problems Sending Faxes

■ Cannot Send a Fax

Cause	Action
The machine is not powered on.	<ul style="list-style-type: none"> You cannot send faxes if the power is turned off. Press the ON/OFF button to turn the power on. After a power failure or disconnecting of the power cord, press the ON/OFF button to turn the power on.
The In Use/Memory lamp is flashing.	Another document is being sent from memory. Wait until the machine finishes sending it.
The telephone line is connected to the External Device Jack.	Reconnect to the Telephone Line Jack. Refer to your setup sheet. If you still cannot send a fax, there is a problem with the telephone line. Contact your telephone company and the manufacturer of your terminal adapter or telephone adapter.
The telephone line type is not set correctly.	If the telephone line type is not set correctly, you will not be able to send faxes, but will still be able to receive them. In this case, check the telephone line type setting and change it as necessary. See "Setting the Telephone Line Type" on page 30.
DIAL TONE DETECT is set to ON .	Resend the fax after a while. If you still cannot send the fax, set DIAL TONE DETECT to OFF .
The fax number is not correctly registered in a speed dial.	Make sure that the fax number is correctly registered when speed dialing. See "Registering Coded Speed Dialing" on page 37.
There was an error during transmission.	<ul style="list-style-type: none"> Check the LCD for an error message. See "An Error Message Is Displayed on the LCD" on page 76. Print the Activity report and check for an error. See "Printing the Activity Report Manually" on page 55.
Cannot hear the dial tone.	Check that the telephone line is connected correctly to the proper jack. If so, then there is a problem with your telephone line. Contact your telephone line provider.
The document is not loaded properly.	Remove the document then reload it on the Platen Glass. See "Loading Original Documents" on page 8.
A fax destination is displayed on the LCD.	Another document is being sent from memory. Wait until the machine finishes sending it.
There was a printer error.	Resolve the printer error. If you are out of paper, set the paper. If you are in a hurry, you can send the fax before resolving the printer error by pressing the Stop/Reset button. In this case, be sure to press the FAX button to print the faxes stored in memory once the transmission is complete.

■ Cannot Send a Fax Clearly

Cause	Action
The document is not loaded correctly, or the Platen Glass or the inner side of the Document Cover is dirty.	<ul style="list-style-type: none">● Remove the document, then reload it on the Platen Glass. See "Loading Original Documents" on page 8.● Clean the Platen Glass or the inner side of the Document Cover, and reload the document. See "Cleaning the Platen Glass and Document Cover" on page 71.
The image quality setting or the scan contrast setting is not suitable for the document.	On the LCD, set an image quality suitable and a scan contrast suitable for the document. See "Adjusting the Scan Contrast or the Image Quality (Fax Resolution)" on page 41.
The document is not loaded with the side to be scanned face down.	When loading the document on the Platen Glass, the side to be scanned should be face down.
You are scanning thick (max. 0.39 inches / 10 mm) or curled documents.	Press on the Document Cover with your hand when scanning.

■ Repeated Errors Occur When You Send a Fax

Cause	Action
The telephone line condition or the connection is poor.	Reduce the transmission start speed. Refer to "TX START SPEED" in "FAX SETTINGS" of the <i>User's Guide</i> on-screen manual. If there is a poor line or connection, reducing the transmission start speed may correct the error.

Telephone Problems

■ Cannot Dial

Cause	Action
The telephone line is not correctly connected.	Check that the telephone line is connected correctly. Refer to your setup sheet.
The telephone line type is not set correctly.	Check the telephone line type setting and change it as necessary. See "Setting the Telephone Line Type" on page 30.

■ Telephone Disconnects During a Call

Cause	Action
The power cord, the telephone line, or the telephone (or another external device such as an answering machine or a computer modem) is not connected securely.	Check that the power cord, the telephone line, and the telephone (or another external device such as an answering machine or a computer modem) are connected securely.

Appendix

How to Use the Documentation Provided

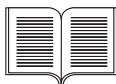

Printed Documentation

Setup Sheet

Be sure to read this sheet first.

This sheet includes instructions for setting up your machine and getting it ready for use.

Quick Start Guide (This guide)

Read this guide when starting to use the machine.

After following instructions in your setup sheet, we recommend you read this guide to familiarize yourself with the basic operation of some of the main functions that can be performed on your machine.



On-screen Manuals

User's Guide

Read this guide when starting to use the machine.

If the *Quick Start Guide* does not provide you enough information please refer to the *User's Guide* which can be installed from the *Setup CD-ROM*. This guide provides detailed instructions for:

- copying
- printing from your computer
- scanning
- faxing

Additional guides are also available for advanced features.

Scanning Guide

Refer to this guide for full instructions on scanning operation and settings.

PC Printing Guide

Refer to this guide for full instructions on printer driver setting.

FAX Driver Guide (Windows only)

Refer to this guide for full instructions on fax driver setting.

PC Photo Printing Guide (Windows only)

Refer to this guide for instructions on using the various application software included on the *Setup CD-ROM*.

Reading the On-screen Manuals

For detailed instructions on installing the on-screen manuals, refer to your setup sheet.

You can view the on-screen manuals in the following way:

Windows

To view the on-screen manual, double-click the **XXX On-screen Manual** shortcut icon on the desktop, or click **Start > All Programs** (or **Programs**) > **Canon XXX Manual > XXX On-screen Manual** (where “**XXX**” is your machine’s name).

System Requirements

Browser: Windows HTML Help Viewer

Note

- Microsoft® Internet Explorer 5.0 or later must be installed.
 - The on-screen manual may not be displayed properly depending on your operating system or Internet Explorer version. We recommend that you keep your system up to date with Windows Update.
-

Macintosh

To view the on-screen manual, double-click the **XXX On-screen Manual** alias (where “**XXX**” is your machine’s name) on the desktop.

System Requirements

Browser: Help Viewer

Note

- The on-screen manual may not be displayed properly depending on your operating system. We recommend that you keep your system up to date.
 - We recommend using Safari as your Web browser to view the HTML format on-screen manuals. If Safari is not installed on your computer, download it from Apple Inc. website and install it.
-

Specifications

General Specifications	
Printing resolution (dpi)	4800 (horizontal)* x 1200 (vertical) * Ink droplets can be placed with a pitch of 1/4800 inch at minimum.
Interface	USB 2.0 High Speed* * A computer that complies with USB 2.0 Hi-Speed standard is required. Since the USB 2.0 Hi-Speed interface is fully upwardly compatible with USB Full-Speed (USB 1.1), it can be used at USB Full-Speed (USB 1.1).
Print width	8 inches / 203.2 mm max. (for Borderless Printing: 8.5 inches / 216 mm)
Acoustic noise level	Approx. 39.5 dB (A) * When printing in the highest print quality mode on Photo Paper Pro.
Operating environment	Temperature: 5 to 35°C (41 to 95°F) Humidity: 10 to 90% RH (no condensation)
Storage environment	Temperature: 0 to 40°C (32 to 104°F) Humidity: 5 to 95% RH (no condensation)
Power supply	AC 100-240 V, 50/60 Hz
Power consumption	Printing (Copy): Approx. 13 W Standby (minimum): Approx. 1.7 W OFF: Approx. 1.0 W
External dimensions	Approx. 18.4 (W) x 17.3 (D) x 6.9 (H) inches / Approx. 465 (W) x 440 (D) x 174 (H) mm * With the Paper Support and Paper Output Tray retracted.
Weight	Approx. 7.0 kg (Approx. 15.5 lb.) * With the FINE Cartridges installed.
Canon FINE Cartridges	Nozzles: Black: 320 nozzles Cyan/Magenta/Yellow: 384 x 3 nozzles

Copy Specifications	
Multiple copy	1 - 99 pages
Intensity adjustment	9 positions, Auto intensity (AE copy)
Zoom	25% - 400% (1% unit)

Scan Specifications	
Scanner driver	TWAIN / WIA (Windows Vista and Windows XP only)
Maximum scanning size	A4/Letter, 8.5" x 11.7" / 216 x 297 mm
Scanning resolution	Optical resolution (horizontal x vertical) max: 600 dpi x 1200 dpi Interpolated resolution max: 19200 dpi x 19200 dpi
Gradation (Input/Output)	16bit/8bit 48bit/24bit (RGB each 16bit/8bit)

Fax Specifications	
Applicable line	Public Switched Telephone Network (PSTN)
Compatibility	G3 / Super G3 (Mono & Color Fax)
Data compressing system	MH, MR, MMR, JPEG
Modem type	Fax modem
Modem speed	33600 / 31200 / 28800 / 26400 / 24000 / 21600 / 19200 / 16800 / 14400 / 12000 / 9600 / 7200 / 4800 / 2400 bps Automatic fallback
Transmission speed	Black & white: Approx. 3 seconds/page at 33.6 Kbps, ECM-MMR, transmitting from memory (Based on ITU-T No.1 chart for US specifications and Canon FAX Standard chart No.1 for others, both in standard mode or Canon FAX Standard chart No.1, standard mode.) Color: Approx. 1 minute/page at 33.6 Kbps, ECM-JPEG, transmitting from memory (Based on Canon COLOR FAX TEST SHEET.)
Scanning image processing	Halftones: 256 levels of gray Density adjustment: 3 levels
Memory	Transmission/reception: 50 pages (Based on ITU-T No.1 chart for US specifications and Canon FAX Standard chart No.1 for others, both in standard mode.)
Fax resolution	Black & white STANDARD : 8 pels / mm x 3.85 lines / mm (203 pels / inch x 98 lines / inch) Black & white FINE, PHOTO : 8 pels / mm x 7.70 lines / mm (203 pels / inch x 196 lines / inch) Color: 200 x 200 dpi
Dialing	Automatic dialing Coded speed dialing (20 destinations) Regular dialing (with numeric buttons) Automatic redialing Manual redialing (with the Redial/Pause button)
Telephone Networking	Automatic reception Automatic fax/tel switchover DRPD (Distinctive Ring Pattern Detection) Remote reception by telephone (Default ID: 25) ECM deactivation Activity report (after every 20 transactions) Non-delivery report TTI (Transmit Terminal Identification)

Telephone Specifications	
Connection	Telephone/answering machine (CNG detecting signal)/data modem

Camera Direct Print (PictBridge)

Paper size	4" x 6" / 101.6 x 152.4 mm, 5" x 7" / 127.0 x 177.8 mm*, Credit card, 8" x 10" / 203.2 x 254.0 mm, A4, Letter, Wide* * Can be selected only on certain Canon-brand PictBridge compliant devices.
Paper type	Default (Selections based on the machine setting), Photo (Photo Paper Plus Glossy, Glossy Photo Paper, Glossy Photo Paper "Everyday Use", Photo Paper Glossy, Photo Paper Plus Semi-gloss, Photo Stickers), Fast Photo (Photo Paper Pro), Plain Paper (A4/Letter only)
Layout	Default (Selections based on the machine setting), Borderless, Bordered, N-up (2, 4, 9, 16) ^{*1} , 35-up ^{*2} ^{*1} Layout compatible with Canon-brand sticker above. Refer to "Printing Media" in the <i>User's Guide</i> on-screen manual. ^{*2} Selected photos are printed in 35 mm film style layout (contact printing layout). This print setting is only available with certain Canon-brand PictBridge compliant devices. You can print shooting Info (Exif Data) on photos in list format, or in the margins of specified photos. Select Layout, then select the item displayed with the [i] icon. (Note that this print setting cannot be used for some models.)
Image optimize	Default (Selections based on the machine setting), On, Off, "VIVID"*, "NR" (Noise Reduction)*, "Face"*, "Red eye"* * If using a Canon PictBridge compliant camera, you can select it.
Print data & file no.	Default (Off: No printing), Date, File No., Both, Off
Trimming	Default (Off: No trimming), On (follow camera's setting), Off

Minimum System Requirements

Note

Conform to the operating system's requirements when higher than those given here.

	Windows	Macintosh
Operating System	Windows Vista	Mac OS X v.10.4
Processor	Pentium II (including compatible processors) 300 MHz	Intel processor
RAM	128 MB	PowerPC G3 256 MB
	Windows XP SP1, SP2 Pentium II (including compatible processors) 300 MHz	Mac OS X v.10.2.8 - v.10.3 PowerPC G3 128 MB
	128 MB	Note: Hard disk must be formatted as Mac OS Extended (Journaled) or Mac OS Extended.
	Windows 2000 Professional SP2, SP3, SP4 Pentium II (including compatible processors) 300 MHz	
	128 MB	
	Note: Operation can only be guaranteed on a PC pre-installed Windows Vista, XP or 2000.	
Browser	Internet Explorer 6.0-	Safari
Hard Disk Space	800 MB	450 MB
	Note: For bundled software installation.	Note: For bundled software installation.
CD-ROM Drive	Required	
Other restrictions	XGA 1024 x 768	

- OmniPage SE: Windows 2000 Professional SP2 and SP3 not supported
- MP Navigator EX: QuickTime v6.4 or later is needed (Macintosh only)
- Some functions may not be available with Windows Media Center
- To upgrade from Windows XP to Windows Vista, first uninstall software bundled with the Canon inkjet printer.

Additional System Requirements for On-Screen Manuals

Windows

Browser: Windows HTML Help Viewer

Note: Microsoft Internet Explorer 5.0 or later must be installed. The on-screen manual may not be displayed properly depending on your operating system or Internet Explorer version. We recommend that you keep your system up to date with Windows Update.

Macintosh

Browser: Help Viewer

Note: The on-screen manual may not be displayed properly depending on your operating system or Help Viewer version. We recommend that you keep your system up to date with Software Update.

Specifications are subject to change without notice.

▲ Safety Precautions

Please read the safety warnings and cautions provided in this manual to ensure that you use the machine safely. Do not attempt to use the machine in any way not described in this manual.

▲ Warning

- This product emits low level magnetic flux. If you use a cardiac pacemaker and feel abnormalities, please move away from this product and consult your doctor.
- You may cause an electric shock, fire, or damage the machine if you ignore any of these safety precautions.

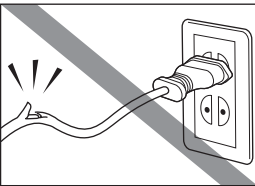
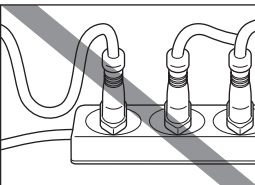
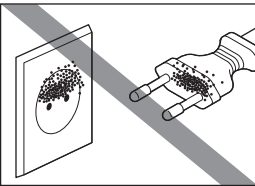
Choosing a location	Do not place the machine close to flammable solvents such as alcohol or thinners.	
Power supply	Never attempt to plug in or unplug the machine from the power supply when your hands are wet.	
	Always push the plug all the way into the power outlet.	
	Never damage, modify, stretch or excessively bend or twist the power cord. Do not place heavy objects on the power cord.	
	Never plug the machine into a power socket that is shared with other equipment (extension lead/cord, 2- or 3-way adapter, etc.).	
	Never use the machine if the power cord is bundled or knotted.	
	If you detect smoke, unusual smells or strange noises around the machine, immediately unplug the machine at the power supply and call for service.	
	Periodically, unplug the machine and use a dry cloth to wipe off any dust or dirt collected on the plug and the power outlet. If the machine is placed at a location exposed to a lot of dust, smoke, or high humidity, the dust collected on the plug absorbs moisture and may cause insulation failure and fire.	
If you hear thunder, disconnect the power supply of the machine and refrain from using it. Leaving the machine plugged in may cause fire, electric shock, or damage to the machine, depending on the thunder storm.		
Use the power cable included with the machine.		

<p>Cleaning the machine</p>	<p>Use a damp cloth to clean the machine. Never use flammable solvents such as alcohol, benzene or thinners. If flammable solvents come in contact with electrical components inside the machine, it could cause a fire or electric shock.</p>	
<p>Always unplug the machine from the power outlet before cleaning the machine. If you accidentally switch the machine on while cleaning it, you could injure yourself or damage the machine.</p>		
<p>Maintaining the machine</p>	<p>Do not attempt to disassemble or modify the machine. There are no user serviceable parts inside the machine. The machine contains high-voltage components. Never attempt any maintenance procedure not described in this guide.</p>	
<p>Working around the machine</p>	<p>Do not use highly flammable sprays near the machine. This could cause a fire or electric shock if the spray comes into contact with electrical components inside the machine.</p>	

⚠ Caution

You may cause injury or damage the machine if you ignore any of these safety precautions.

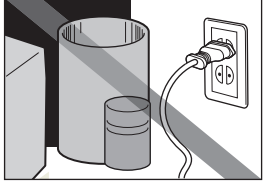
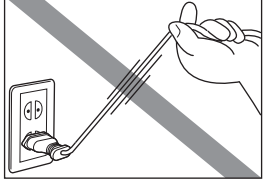
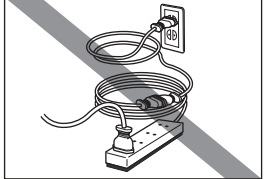
<p>Choosing a location</p>	<p>Do not install the machine in a location that is unstable or subject to excessive vibration. Do not install the machine in locations that are very humid or dusty, in direct sunlight, outdoors, or close to a heating source. To avoid the risk of fire or electric shocks, install the machine in a location with an ambient temperature range of 5°C to 35°C (41°F to 95°F) and humidity of 10% to 90% (condensation free). Do not place the machine on a thick rug or carpet. Do not place the machine with its back attached to the wall.</p>	
<p>Power supply</p>	<p>Ensure that the area around the power outlet is kept clear at all times so you can easily unplug the power cord if necessary.</p>	
<p>Never remove the plug by pulling on the cord.</p>		
<p>Do not use an extension lead/cord.</p>		

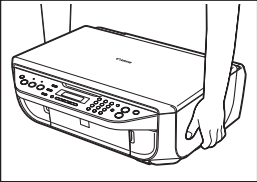
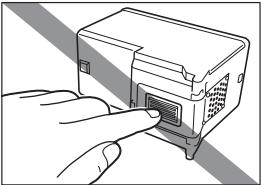
Working around the machine	Never put your hands or fingers in the machine while it is printing.
	When moving the machine, carry the machine at both ends. 
	Do not place any object on the machine.
	Do not place metal objects (paper clips, staples, etc.) or containers of flammable solvents (alcohol, thinners, etc.) on top of the machine.
	If any foreign object (metal or liquid) fall into the machine, unplug the power cord and call for service.
	Do not transport or store the machine on a slant, vertically or upside-down, as the ink may leak and damage the machine.
When loading a thick book on the Platen Glass, do not press hard on the Document Cover. The Platen Glass may break and cause injury.	
FINE Cartridges (Ink Cartridges)	For safety reasons, store FINE Cartridges (Ink Cartridges) out of the reach of small children. If a child ingests any ink, consult a doctor immediately.
	Do not shake FINE Cartridges (Ink Cartridges). Ink may spill out and stain clothing or the surrounding area.
	Never touch the electrical contacts or Print Head Nozzles on a FINE Cartridge (Ink Cartridge) after printing. The metal parts may be very hot and could cause burns. 
	Do not throw FINE Cartridges (Ink Cartridges) into fire.

IMPORTANT SAFETY INSTRUCTIONS

When using your telephone equipment, basic safety precautions should always be followed to reduce the risk of fire, electric shock and injury to persons, including the following:

1. Do not use this product near water, for example, near a bath tub, wash bowl, kitchen sink or laundry tub, in a wet basement or near a swimming pool.
2. Avoid using this product during an electrical storm. There may be a remote risk of electric shock from lightning.
3. Do not use this product to report a gas leak in the vicinity of the leak.

SAVE THESE INSTRUCTIONS

Legal Limitations on Use of Your Product and Use of Images

It may be unlawful to make copies of, scan, print, or use reproductions of the following documents. The list provided is non-exhaustive. When in doubt, check with a legal representative in your jurisdiction.

- Paper money
- Money orders
- Certificates of deposit
- Postage stamps (canceled or uncanceled)
- Identifying badges or insignias
- Selective service or draft papers
- Checks or drafts issued by governmental agencies
- Motor vehicle licenses and certificates of title
- Traveler's checks
- Food stamps
- Passports
- Immigration papers
- Internal revenue stamps (canceled or uncanceled)
- Bonds or other certificates of indebtedness
- Stock certificates
- Copyrighted works/works of art without permission of copyright owner

Users in the U.S.A.

■ Pre-Installation Requirements for MX300

Order Information

When ordering service from the telephone company for this equipment, the following may be required.

Universal Service Order Code (USOC): RJ11C

The Facility Interface Code (FIC): 02LS2

Service Order Code (SOC): 9.0F

■ Connection of the Equipment

This equipment complies with Part 68 of the FCC rules and the requirements adopted by the ACTA. On the bottom of this equipment is a label that contains, among other information, a product identifier in the format US:AAAEQ##TXXXX. If requested, this number must be provided to the telephone company.

The REN is used to determine the number of devices that may be connected to a telephone line. Excessive RENs on a telephone line may result in the devices not ringing in response to an incoming call. In most but not all areas, the sum of RENs should not exceed five (5.0). To be certain of the number of devices that may be connected to a line, as determined by the total RENs, contact the local telephone company. The REN for this product is part of the product identifier that has the format US:AAAEQ##TXXXX. The digits represented by ## are the REN without a decimal point (e.g., 03 is a REN of 0.3).

A plug and jack used to connect this equipment to the premises wiring and telephone network must comply with the applicable FCC Part 68 rules and requirements adopted by the ACTA. A compliant telephone cord and modular plug is provided with this product. It is designed to be connected to a compatible modular jack that is also compliant. See installation instructions for details.

Connection to party lines is subjected to state tariffs. Contact the state public utility commission, public service commission or corporation commission for information.

If your home has specially wired alarm equipment connected to the telephone line, ensure the installation of this equipment does not disable your alarm equipment. If you have questions about what will disable alarm equipment, consult your telephone company or a qualified installer.

■ In Case of Equipment Malfunction

Should any malfunction occur which cannot be corrected by the procedures described in this guide, disconnect the equipment from the telephone line cable, turn off the power and disconnect the power cord. The telephone line cable should not be reconnected or the main power switch turned ON until the problem is completely resolved. Users should contact their local authorized Canon Facsimile Service Dealer for the servicing of equipment.

Information regarding Authorized Service Facility locations can be obtained by calling the Canon Customer Center.

■ Rights of the Telephone Company

If this equipment causes harm to the telephone network, the telephone company may temporarily disconnect service. The telephone company also retains the right to make changes in facilities and services that may affect the operation of this equipment. When such changes are necessary, the telephone company is required to give adequate prior notice to the user. However, if advance notice is not possible, the telephone company will notify the customer as soon as possible. Also, the customer will be advised of his/her right to file a complaint with the FCC if he/she believes it is necessary.

Warning

The Telephone Consumer Protection Act of 1991 makes it unlawful for any person to use a computer or other electronic device to send any message via a telephone FAX machine unless such message clearly contains in a margin at the top or bottom of each transmitted page, or on the first page of the transmission, the date and time it is sent and an identification of the business or other entity, or other individual sending the message and the telephone number of the sending machine or such business, other entity, or individual.

In order to program this information into your FAX machine, you should complete the procedure to register your name, unit's telephone number, time, and date. See "Registering Sender Information" of this guide.

■ **Regulatory Information**

FCC Notice (U.S.A. Only)

For 120V, 60Hz model

Model Number: K10302

This device complies with Part 15 of the FCC Rules. Operation is subject to the following two conditions: (1) This device may not cause harmful interference, and (2) this device must accept any interference received, including interference that may cause undesired operation.

Note: This equipment has been tested and found to comply with the limits for a Class B digital device, pursuant to Part 15 of the FCC Rules. These limits are designed to provide reasonable protection against harmful interference in a residential installation. This equipment generates, uses and can radiate radio frequency energy and, if not installed and used in accordance with the instructions, may cause harmful interference to radio communications.

However, there is no guarantee that interference will not occur in a particular installation. If this equipment does cause harmful interference to radio or television reception, which can be determined by turning the equipment off and on, the user is encouraged to try to correct the interference by one or more of the following measures:

- Reorient or relocate the receiving antenna.
- Increase the separation between the equipment and receiver.
- Connect the equipment into an outlet on a circuit different from that to which the receiver is connected.
- Consult the dealer or an experienced radio/TV technician for help.

Use of a shielded cable is required to comply with Class B limits in Subpart B of Part 15 of the FCC Rules.

Do not make any changes or modifications to the equipment unless otherwise specified in the manual. If such changes or modifications should be made, you could be required to stop operation of the equipment.

Canon U.S.A., Inc.
One Canon Plaza
Lake Success, NY 11042
1-516-328-5600

■ **Canon U.S.A., INC. LIMITED WARRANTY --- (USA Only)**

The limited warranty set forth below is given by Canon U.S.A., Inc. ("Canon USA") with respect to the new or refurbished Canon-brand product ("Product") packaged with this limited warranty, when purchased and used in the United States only.

The Product is warranted against defects in materials and workmanship under normal use and service (a) for a period of one (1) year from the date of original purchase when delivered to you in new condition in its original container or (b) for 90 days from the date of original purchase for refurbished Products. Product returned to a Canon USA repair facility or a Canon USA Authorized Service Facility ("ASF"), and proven to be defective upon inspection will be (a) repaired utilizing new, remanufactured, repaired and/or recycled parts (b) exchanged for new or; (c) exchanged for a

refurbished Product, as determined by the Canon USA repair facility or the ASF. Warranty repair or replacement shall not extend the original warranty period of the Product. A dated proof of purchase is required at the time of warranty service. A copy of your dated bill of sale will satisfy this requirement. This warranty does not cover any accessories, or any consumables, such as paper or ink cartridges, as to which there shall be no warranty or replacement.

This limited warranty shall only apply if the Product is used in conjunction with compatible computers, peripheral equipment and software. Canon USA shall have no responsibility for such items except for compatible Canon brand peripheral equipment covered by a separate warranty ("Separate Warranty"). Repairs of such Canon brand peripheral equipment shall be governed by the terms of the Separate Warranty. Non-Canon brand equipment and software that may be distributed with the Product are sold "as is" and without warranty of any kind by Canon USA, including any implied warranty regarding merchantability or fitness for a particular purpose, and all such warranties are disclaimed. The sole warranty, if any, with respect to such non-Canon brand items is given by the manufacturer or producer thereof.

This limited warranty covers all defects encountered in normal use of the Product and does not apply in the following cases:

- (a) Loss of or damage to the Product due to abuse, neglect, mishandling, improper packaging by you, alteration, accident, electrical current fluctuations, improper use, failure to follow operating or maintenance instructions in, or environmental conditions prescribed in, Canon USA's user's manual or other documentation, or services performed by someone other than a Canon USA repair facility or ASF. Without limiting the foregoing, dropping the Product, scratches, and abrasions will be presumed to have resulted from misuse, abuse or failure to operate the Product as set forth in the user's manual or other documentation for the Product.
- (b) Use of parts, media, software or supplies (other than those sold by Canon USA), including non-Canon ink cartridges or refilled ink cartridges, that cause damage to the Product or cause abnormally frequent service calls or service problems.
- (c) If the Product has had its serial number or dating defaced, altered or removed.

ANY SYSTEM SOFTWARE (WHETHER FACTORY LOADED ON THE PRODUCT OR CONTAINED ON THE SOFTWARE DISKETTES OR CD-ROMS ENCLOSED WITH, OR ACCOMPANYING, THE PRODUCT), AND ANY UTILITY SOFTWARE, DISTRIBUTED WITH OR FOR THE PRODUCT, IS SOLD "AS IS" AND WITHOUT WARRANTY BY CANON USA. THE SOLE WARRANTY WITH RESPECT TO SUCH SOFTWARE IS CONTAINED IN THE SOFTWARE MANUFACTURER'S LICENSE AGREEMENT DISTRIBUTED THEREWITH, INCLUDING ANY LIMITATIONS AND DISCLAIMERS THEREON. PLEASE CONTACT CANON USA IMMEDIATELY IF YOU HAVE NOT RECEIVED A COPY OF THE SOFTWARE MANUFACTURER'S LICENSE AGREEMENT.

NO IMPLIED WARRANTY, INCLUDING ANY IMPLIED WARRANTY OF MERCHANTABILITY OR FITNESS FOR A PARTICULAR PURPOSE, APPLIES TO THE PRODUCT AFTER THE APPLICABLE PERIOD OF THE EXPRESS LIMITED WARRANTY STATED ABOVE, AND NO OTHER EXPRESS WARRANTY OR GUARANTY, EXCEPT AS MENTIONED ABOVE, GIVEN BY ANY PERSON OR ENTITY WITH RESPECT TO THE PRODUCT SHALL BIND CANON USA, OR ITS ASF. (SOME STATES DO NOT ALLOW LIMITATIONS ON HOW LONG AN IMPLIED WARRANTY LASTS, SO THE ABOVE LIMITATION MAY NOT APPLY TO YOU.) CANON USA SHALL NOT BE LIABLE FOR LOSS OF REVENUES OR PROFITS, INCONVENIENCE, EXPENSE FOR SUBSTITUTE EQUIPMENT OR SERVICE, STORAGE CHARGES, LOSS OR CORRUPTION OF DATA, OR ANY OTHER SPECIAL, INCIDENTAL OR CONSEQUENTIAL DAMAGES CAUSED BY THE USE, MISUSE, OR INABILITY TO USE THE PRODUCT REGARDLESS OF THE LEGAL THEORY ON WHICH THE CLAIM IS BASED, AND EVEN IF CANON USA OR ITS ASF HAS BEEN ADVISED OF THE POSSIBILITY OF SUCH DAMAGES. NOR SHALL RECOVERY OF ANY KIND AGAINST CANON USA OR ITS ASF BE GREATER IN AMOUNT THAN THE PURCHASE PRICE OF THE PRODUCT CAUSING THE ALLEGED DAMAGE. WITHOUT LIMITING THE FOREGOING, YOU ASSUME ALL RISK AND LIABILITY FOR LOSS, DAMAGE OR INJURY TO YOU AND YOUR

PROPERTY AND TO OTHERS AND THEIR PROPERTY ARISING OUT OF THE POSSESSION, USE, MISUSE, OR INABILITY TO USE THE PRODUCT SOLD BY CANON USA NOT CAUSED SOLELY AND DIRECTLY BY THE NEGLIGENCE OF CANON USA, OR ITS ASF. (SOME STATES DO NOT ALLOW THE EXCLUSION OR LIMITATION OF INCIDENTAL OR CONSEQUENTIAL DAMAGES, SO THE ABOVE EXCLUSION OR LIMITATION MAY NOT APPLY TO YOU.) THIS LIMITED WARRANTY SHALL NOT EXTEND TO ANYONE OTHER THAN THE ORIGINAL PURCHASER OF THE PRODUCT OR THE PERSON FOR WHOM IT WAS PURCHASED AS A GIFT, AND STATES YOUR EXCLUSIVE REMEDY.

Canon USA offers a range of customer technical support* options:

- Interactive troubleshooting, e-mail technical support, the latest driver downloads and answers to frequently asked questions (www.canontechsupport.com)
- Toll-free live technical support Monday-Saturday (excluding holidays) at 1-800-828-4040
- Telephone Device for the Deaf (TDD-1-866-251-3752)
- Repair or Exchange Service Options:
In the event service is required for the Product during the limited warranty period, Canon USA offers two hardware support options:

Authorized Service Facility Carry-In / Mail-In Service

Canon USA's Carry-In/Mail-In Service provides repair or exchange, at Canon USA's option, through Canon USA's Authorized Service Facility (ASF) network. The name and telephone number of the ASF(s) near you may be obtained from Canon USA's Web site at www.canontechsupport.com or by calling the Canon USA Customer Care Center at 1-800-828-4040, or any time while speaking to a technical support person. A Product covered by this limited warranty will be repaired or exchanged, as determined by Canon USA, and returned without charge by the ASF.

InstantExchange Service **

A Canon Customer Care Center or ASF technician will attempt to diagnose the nature of the problem and, if possible, correct it over the telephone. If the problem cannot be corrected over the telephone, and you elect the InstantExchange option, a reference number will be issued to you. You will be asked for the Product serial number and other information pertaining to your Product and for a ship-to location for the replacement Product (must include street address).

The Canon USA repair facility will ship out the replacement Product prepaid by Canon USA. After receipt of the replacement Product (with instructions and a prepaid waybill), follow the enclosed instructions on how to ship your product to the Canon USA repair facility. Your Product must be returned in the shipping carton in which the replacement Product was packed and include the reference number, A COPY OF YOUR DATED PROOF OF PURCHASE (BILL OF SALE), and a complete explanation of the problem. DO NOT INCLUDE ANY OTHER ITEMS WITH THE YOUR PRODUCT IN THE RETURN SHIPPING CARTON, AND BE SURE TO RETAIN YOUR PRINTHEAD, INK CARTRIDGE(S) AND TANK(S).

InstantExchange Service exchanges your Product with a replacement Product, which will normally be shipped the same day if your request for this service is by 3 p.m. E.T. Monday through Friday, except holidays. Canon USA does not guarantee same day shipment in the event of the occurrence of factors beyond its reasonable control. The replacement Product you receive may be a refurbished or reconditioned unit and will be covered for the balance of the period remaining on your original limited warranty. NOTE THAT BY USING THIS SERVICE YOU WILL KEEP THE REPLACEMENT PRODUCT THAT IS SENT TO YOU. CANON USA WILL RETAIN THE PRODUCT THAT YOU ORIGINALLY PURCHASED, WHICH SHALL BECOME THE PROPERTY OF CANON USA. InstantExchange warranty program service is available only during the express limited-warranty period for your Product and only in the continental United States, Alaska and Hawaii during such period.

This limited warranty gives you specific legal rights, and you may also have other rights, which vary from state to state.

* Support program specifics are subject to change without notice.

** InstantExchange warranty service is subject to the availability of refurbished or new replacement units.

Canon U.S.A., Inc.
One Canon Plaza
Lake Success, NY 11042
USA

Canon is a registered trademark of Canon Inc.

©2007 Canon U.S.A., Inc. Canon is a registered trademark of Canon Inc. in the United States and may also be a registered trademark in other countries.

Users in Canada

■ Pre-Installation Requirements for Canon Facsimile Equipment

Notice

This equipment meets the applicable Industry Canada technical specifications.

The Ringer Equivalence Number is an indication of the maximum number of devices allowed to be connected to a telephone interface. The termination on an interface may consist of any combination of devices subject only to the requirement that the sum of the RENs of all the devices does not exceed five.

Avis

Le présent matériel est conforme aux spécifications techniques applicables d'Industrie Canada.

L'indice d'équivalence de la sonnerie (IES) sert à indiquer le nombre maximal de terminaux qui peuvent être raccordés à une interface téléphonique. La terminaison d'une interface peut consister en une combinaison quelconque de dispositifs, à la seule condition que la somme d'indices d'équivalence de la sonnerie de tous les dispositifs n'excède pas 5.

Users in New Zealand

The grant of a Telepermit for any item of terminal equipment indicates only that Telecom has accepted that the item complies with minimum conditions for connection to its network. It indicates no endorsement of the product by Telecom, nor does it provide any sort of warranty. Above all, it provides no assurance that any item will work correctly in all respects with another item of Telepermitted equipment of a different make or model, nor does it imply that any product is compatible with all of Telecom's network services.

Telepermitted equipment only may be connected to the auxiliary telephone port. The auxiliary telephone port is not specifically designed for 3-wire connected equipment that may not respond to incoming ringing when attached to this port.

The automatic calling functions of this equipment must not be used to cause a nuisance to other Telecom customers.

This equipment must not be programmed for decadic (pulse) dialling.

Index

A

Appendix 96

B

Before Using the Machine 2

C

Canon U.S.A., Inc. Limited Warranty - U.S. Only
107

Cleaning

exterior 71

inside 73

platen glass and document cover 71

protrusions inside the machine 74

roller 72

Copying 17

E

Error Message 76

F

Faxing

preparing 28

receiving 45

sending 40

H

Handling Original Documents 8

L

Legal Limitations on Use of Your Product and Use
of Images 105

Loading Original Documents 8

Loading Printing Paper

envelopes 14

paper 12

recommended paper and requirements 10

small-sized paper 16

M

Media

cannot use 11

specialty 9

Media Type 10

N

Nozzle Check Pattern

examining 59

printing 58

P

Print Head

aligning 62

cleaning 60

deep cleaning 61

Printing from Your Computer

Macintosh 21

Windows 20

Printing Photographs Directly from a Compliant

Device 23

PictBridge print settings 25

R

Replacing a FINE Cartridge 64

ink status information 64

Routine Maintenance 57

S

Safety Precautions 102

Scanning Images 22

Specialty Media 9

Specifications 98

copy 98

fax 99

general 98

PictBridge 100

scan 98

telephone 99

System Requirements 101

T

Troubleshooting 75

Turning off the Machine 6

Turning on the Machine 6

Ordering Information

For additional supplies, use the following descriptions and order numbers.

Description	Order #
FINE Cartridges	
PG-30 Black	1899B002
CL-31 Color	1900B002
PG-40 Black	0615B002
CL-41 Color	0617B002
PG-50 Black	0616B002
CL-51 Color	0618B002
Canon Specialty Papers	
All Occasion Photo Cards (4" x 8"/ 50 sheets)	1029A069
Glossy Photo Paper Credit Card Size (100 sheets)	9157A023
High Resolution Paper (8.5" x 11"/ 100 sheets)	1033A011
Matte Photo Paper (4" x 6"/ 120 sheets)	7981A014
Matte Photo Paper (8.5" x 11"/ 50 sheets)	7981A004
Photo Paper Glossy (4" x 6"/ 50 sheets)	0775B021
Photo Paper Glossy (4" x 6"/ 100 sheets)	0775B022
Photo Paper Glossy (8.5" x 11"/ 50 sheets)	0775B023
Photo Paper Glossy (8.5" x 11"/ 100 sheets)	0775B024
Photo Paper Plus Double Sided (5" x 7"/ 10 sheets)	9981A006
Photo Paper Plus Double Sided (8.5" x 11"/ 10 sheets)	9981A005
Photo Paper Plus Double Sided Album Kit (5" x 7")	0041B005
Photo Paper Plus Double Sided Album Kit (8.5" x 11")	0041B006
Photo Paper Plus Glossy (4" x 6"/ 50 sheets)	7980A012
Photo Paper Plus Glossy (4" x 6"/ 120 sheets)	7980A022
Photo Paper Plus Glossy (5" x 7"/ 20 sheets)	7980A019
Photo Paper Plus Glossy (8.5" x 11"/ 20 sheets)	7980A006
Photo Paper Plus Semi-gloss (4" x 6"/ 50 sheets)	1686B014
Photo Paper Plus Semi-gloss (8" x 10" / 20 sheets)	1686B017
Photo Paper Plus Semi-gloss (8.5" x 11"/ 20 sheets)	1686B020
Photo Paper Pro (4" x 6"/ 20 sheets)	1029A014
Photo Paper Pro (4" x 6"/ 75 sheets)	1029A027
Photo Paper Pro (8" x 10"/ 20 sheets)	1029A059
Photo Paper Pro (8.5" x 11"/ 15 sheets)	1029A004
Photo Paper Pro (8.5" x 11"/ 30 sheets)	1029A028
Photo Stickers (16 stickers/sheet, 5 sheets/pack)	0001C001

Call **1-800-OK-CANON** to locate a dealer near you, or visit the Canon eStore at www.estimate.usa.canon.com.



© 2007 Canon U.S.A., Inc. Canon is a registered trademark of Canon Inc. in the United States and may be a registered trademark or trademarks in other countries. All other product and brand names are trademarks of their respective owners. As an ENERGY STAR® partner, Canon U.S.A., Inc. has determined that this product meets the ENERGY STAR® guidelines for energy efficiency.

The following FINE Cartridges are compatible with this product.



For information on product specifications, please visit our website at www.usa.canon.com